



System connection diagram

• Our Unique Position

Distinct Design & manufacturer of Intelligent lighting Solutions .

• About

PAST:

founded in 2013, provide lighting products for customers.

• Present:

Leading lighting solution provider .

• Future:

Smart Lighting lighting products and Exceptional After Sales service for End Users.

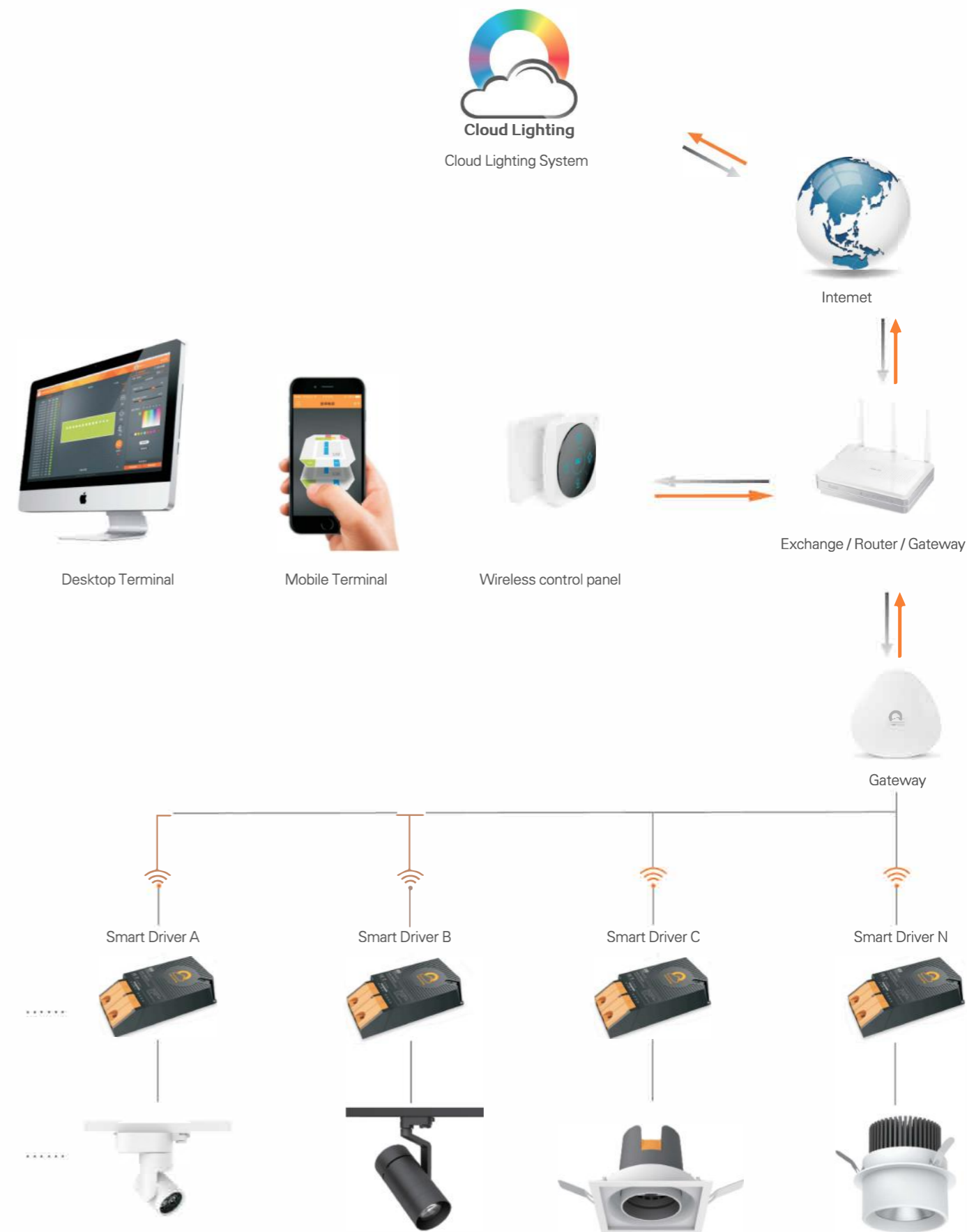



Components



CLS-Server

Data:
 Input Voltage: 220V
 Power: 200W
 HD Capacity: 1T-2T
 DDR Capacity: 2G
 CPU: Intel Xeon-E3

Dimension:

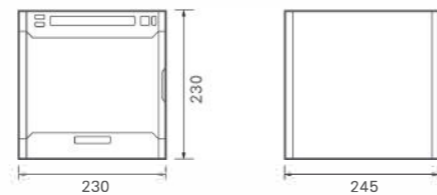

HiWiFi

Data:
 Working Temp.: -20 ~ 50°C
 Voltage: 220V
 Transfer Frequency Range: 2.412~2.472GHZ
 Weight: 300g
 Driver :5V/1A



CLS-Gateway

Data:
 Input Voltage: 5V
 Input Current: 800mA
 System: Zigbee
 Frequency: 2.4GHz
 Installation: Independent

Dimension:

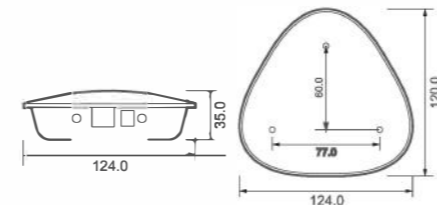

CLS-Panel

Data:
 Input Voltage: 100-240V AC/50-60Hz
 Input Current: 0.1A
 Frequency: 50/60Hz
 Input Voltage: 5V DC
 Output Current: 0.2A
 System: Zigbee
 Frequency: 2.4GHz
 Control : Touch Control
 Installation: 86 Box Wall-mounted

Dimension:

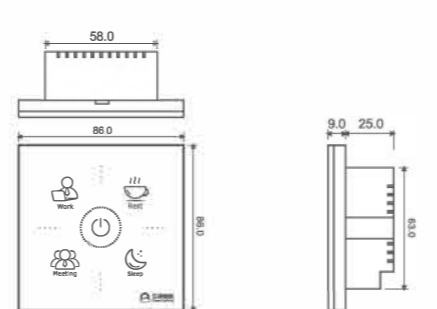

Clouds Moving Series



Product Feature :

- Intelligent, batch adjustable for the position and lighting direction of the track light, so as to adapt to different kinds of commercial application.
 - can adjust the beam angle freely, apply for different kinds of lighting demand.
 - RGB color temperature can create and contrast perfect atmosphere.
 - Remote background batch lighting management.
- Relying on cloud lighting platform,create the convenient, highly efficient, intelligent lighting management network.

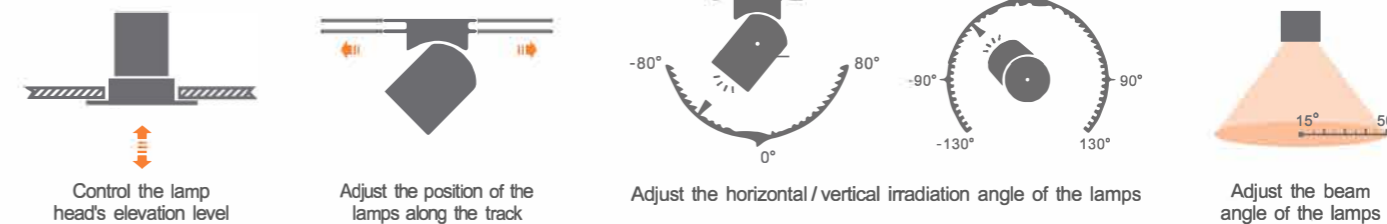



Track Light

Clouds Moving Series



LP-0948-20
COB 20W
Φ92mm



LP-0948-30
COB 30W
Φ92mm



LP-0948-50
LED 50W
Φ121mm



LP-0950-20
COB 20W
Φ92mm



LP-0950-30
COB 30W
Φ92mm



LP-0950-50
COB 50W
Φ121mm

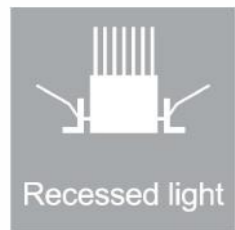

Recessed light



LP-0948-20
LED 20W



LP-0948-30
LED 30W



LP-0948-50
LED 50W
CUT-OUT : Φ176mm



LP-0950-20
COB 20W



LP-0950-30
COB 30W



LP-0950-50
COB 50W
CUT-OUT : Φ176mm

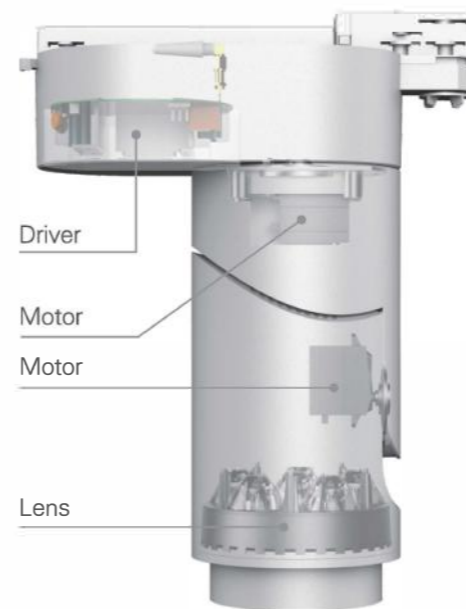

LP-A0948-20

Lamp: XPL
Power: 20W
Voltage: 19.5V
CCT: 3000K
CRI: 90
Beam Angle: 10° ± 2°
Tilting Angle: 150°
Φ92mm



LP-A0948-50

Lamp: XPL
Power: 50W
Voltage: 19.5V
CCT: 3000K
CRI: 90
Beam Angle: 10° ± 2°
Tilting Angle: 150°
Φ121mm

UNIT:mm

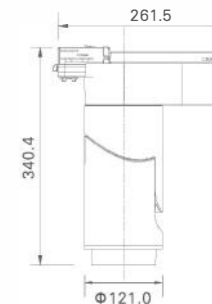
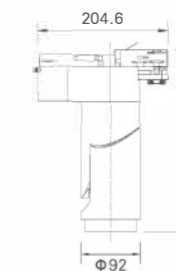

Beam angle

Lamp: XPL 20W

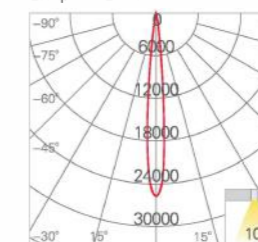

Lamp: XPL 30W

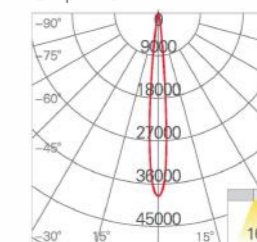

Lamp: XPL 50W

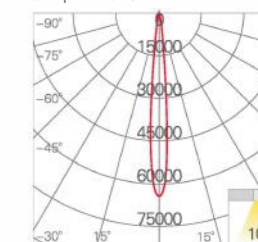

Colors



Black



White





Track light

Easily installed and disinstalled glareproof grille
Can also installed barn door

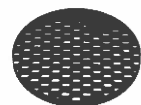

Honey Comb



Cross-louvre

LP-0950-20

Lamp: TX1936SW
Power: 20W
Voltage: 19.5 V
CCT: 3000K
CRI: 90
Beam Angle: 10° ± 2°
Tilting Angle: 150°
Φ92mm

LP-0950-30

Lamp: TX1936SW
Power: 30W
Voltage: 19.5 V
CCT: 3000K
CRI: 90
Beam Angle: 10° ± 2°
Tilting Angle: 150°
Φ92mm

LP-0950-50

Lamp: TX1936SW
Power: 50W
Voltage: 19.5 V
CCT: 3000K
CRI: 90
Beam Angle: 10° ± 2°
Tilting Angle: 150°
Φ121mm

UNIT:mm

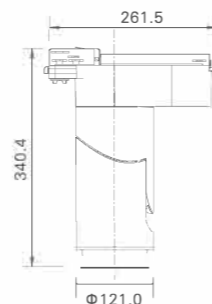
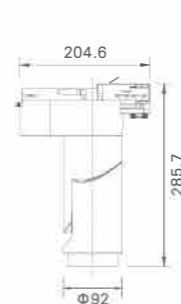

Beam angle TX-1936SW 50W

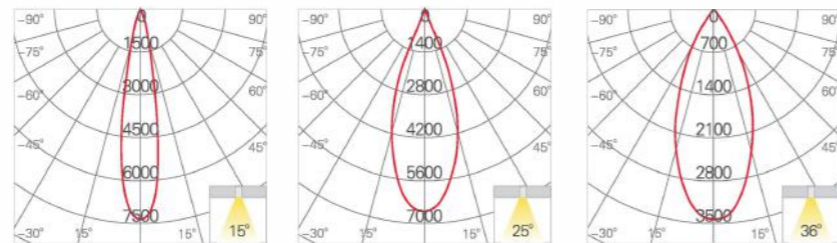

Colors



LP-R0948-20

Lamp: XPL
Power: 20W
Voltage: 19.5 V
CCT: 3000K
CRI: 90
Beam Angle: 10° ± 2°
Tilting Angle: 150°

LP-R0948-30

Lamp: XPL
Power: 30W
Voltage: 19.5 V
CCT: 3000K
CRI: 90
Beam Angle: 10° ± 2°
Tilting Angle: 150°

LP-R0948-50

Lamp: XPL
Power: 50W
Voltage: 19.5 V
CCT: 3000K
CRI: 90
Beam Angle: 10° ± 2°
Tilting Angle: 150°
CUT-OUT: Φ176mm

UNIT:mm

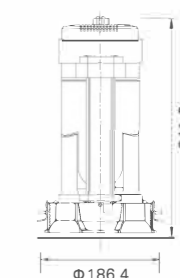

MDR0948-50

Beam angle

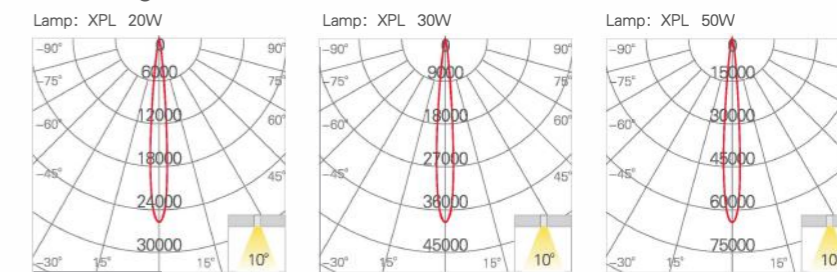

Colors



Rise



Drop

260°

80°

Recessed light





LP-0950-20

Lamp: TX1936SW
Power: 20W
Voltage: 19.5V
CCT: 3000K
CRI: 90
Beam Angle: 10° ±2°
Tilting Angle: 150°
Φ92mm

LP-0950-30

Lamp: TX1936SW
Power: 30W
Voltage: 19.5V
CCT: 3000K
CRI: 90
Beam Angle: 10° ±2°
Tilting Angle: 150°
Φ92mm

LP-0950-50

Lamp: TX1936SW
Power: 50W
Voltage: 19.5V
CCT: 3000K
CRI: 90
Beam Angle: 10° ±2°
Tilting Angle: 150°
CUT-OUT: Φ176mm

UNIT:mm

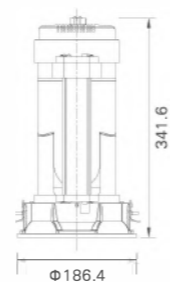

LP-0948-50

Beam angle
LP-1936SW 30W

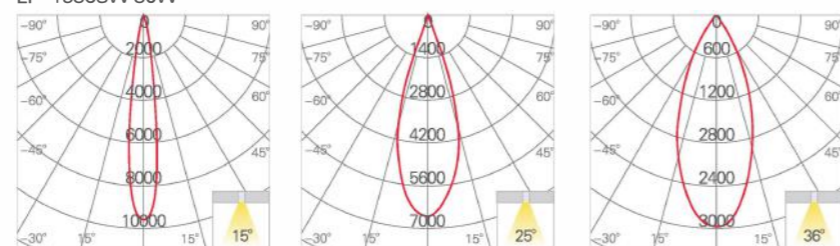

Colors

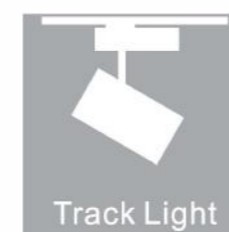

Heras series



ILP-A1008-10
COB 10W
Φ70mm

ILP-A1008-20
COB 20W
Φ70mm

ILP-A1008-30
COB 30W
Φ100mm



ILP-A1008-40
COB 40W
Φ124.5mm

ILP-A1008-50
COB 50W
Φ124.5mm

ILP-A1008-60
COB 60W
Φ124.5mm



Hera series



Cloud Lighting Driver



COB

Focusing Module

Lens

Heat dissipation design

Manual adjustable light beam angle



LP-A1008-10

Lamp: TOYONIA.Y3ES
Power: 10W
Lumens: 78-90LMW
Voltage: 180-240V
CCT: 2700-5000K
CRI: 90
Beam Angle: 15° ~ 50°
Tilting Angle: 90°

LP-A1008-20

Lamp: TOYONIA.Y3ES
Power: 20W
Lumens: 78-90LMW
Voltage: 180-240V
CCT: 2700-5000K
CRI: 90
Beam Angle: 15° ~ 50°
Tilting Angle: 90°

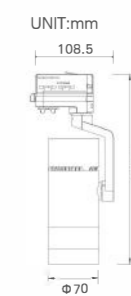

Beam angle

TOYONIA.Y3ES 10W

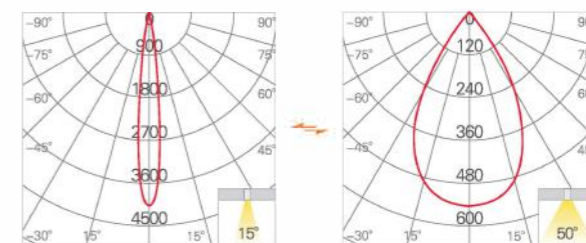

TOYONIA.Y3ES 20W

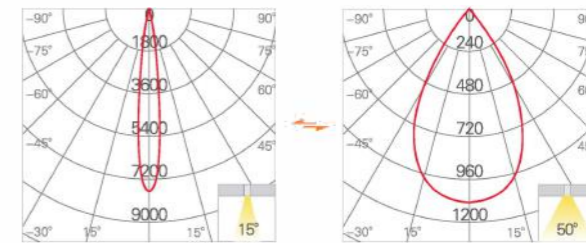

Colors





LP-1008-30

Lamp: TOYONIA.Y3ES
 Power: 30W
 Lumens: 78~90LMW
 Voltage: 180~240V
 CCT: 2700~5000K
 CRI: 90
 Beam Angle: 15° ~ 50°
 Tilting Angle: 90°

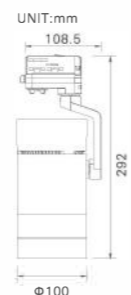

Beam angle
 TOYONIA.Y3ES 30W

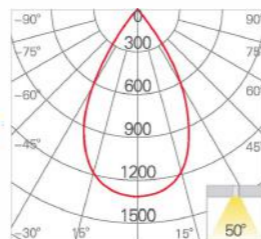
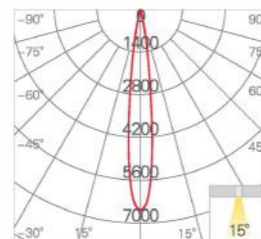

Colors



LP-A1008-40

Lamp: TX-2548SW21A
 -2757V33-01H90
 Power: 30W
 Lumens: 78~90LMW
 Voltage: 180~240V
 CCT: 2700~5700K
 CRI: 90
 Beam Angle: 15° ~ 26°
 Tilting Angle: 90°

LP-A1008-50

Lamp: TX-2548SW21A
 -2757V33-01H90
 Power: 30W
 Lumens: 78~90LMW
 Voltage: 180~240V
 CCT: 2700~5700K
 CRI: 90
 Beam Angle: 15° ~ 26°
 Tilting Angle: 90°

LP-A1008-60

Lamp: TX-2548SW21A
 -2757V33-01H90
 Power: 30W
 Lumens: 78~90LMW
 Voltage: 180~240V
 CCT: 2700~5700K
 CRI: 90
 Beam Angle: 15° ~ 26°
 Tilting Angle: 90°



Beam angle
 TOYONIA.Y3ES 40W

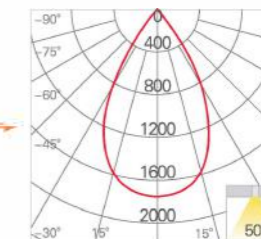
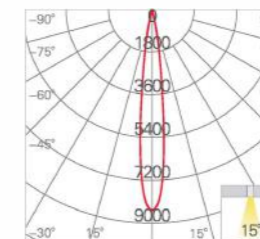

Colors



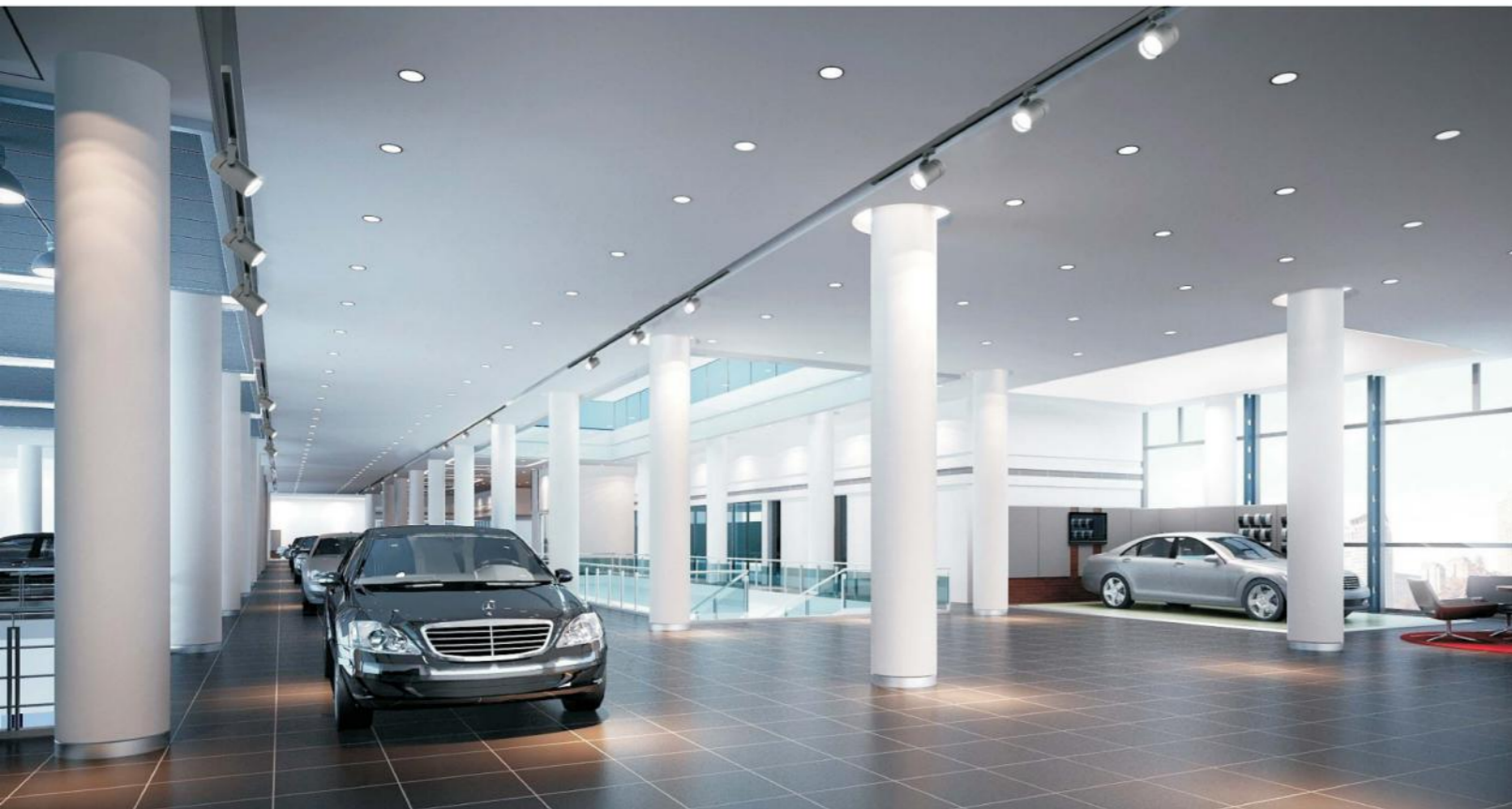

Heba series



Cloud Lighting Driver



Lens

Honey Comb

Cross-louvre

Barndoor



Track Light

Heba series





	Cross-louvre
	Honey Comb
	Barndoor



Easily installed and disinstalled glareproof grille
Can also installed barn door



Cross-louvre
1



Honey Comb
2



Beam angle

TX-1512SW11A-2757V33-01H90 10W

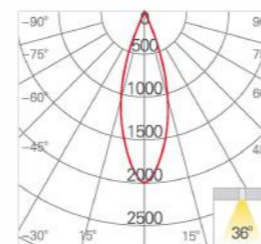
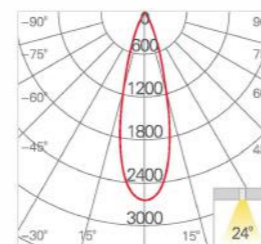
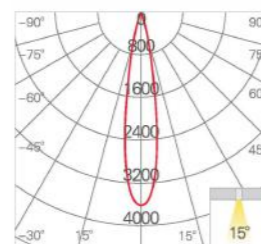

Barndoor



LP-A1009-10

Lamp: TX-1512SW11A-2757V33-01H90
 Power: 10W
 Lumens: 78-90LM/W
 Voltage: 180-240V
 CCT: 2700-5700K
 CRI: 90
 Beam Angle: 15° / 24° / 36°
 Tilting Angle: 90°

LP-A1009-20

Lamp: TX-1512SW11A-2757V33-01H90
 Power: 20W
 Lumens: 78-90LM/W
 Voltage: 180-240V
 CCT: 2700-5700K
 CRI: 90
 Beam Angle: 15° / 24° / 36°
 Tilting Angle: 90°

LP-A1009-GU10

Lamp: GU10
 Lumens: 78-90LM/W
 Voltage: 180-240V
 CRI: 90
 Tilting Angle: 90°

UNIT:mm

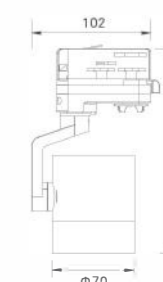
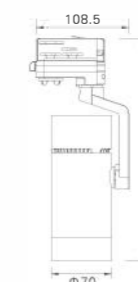

Beam angle

TX-1512SW11A-2757V33-01H90 20W

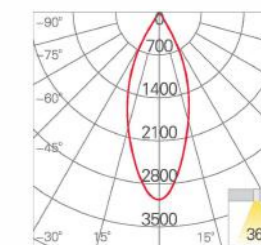
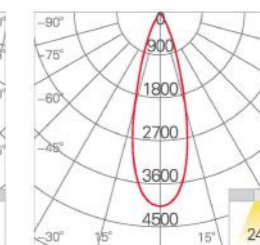
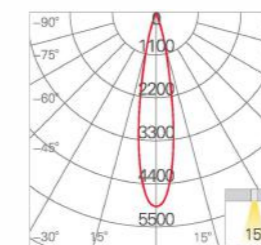

Colors



Black

Silver

White





LP-1009-30

Lamp: TX-1936SW17A
 -2757V33-01H90
 Power: 30W
 Lumens: 78-90LM/W
 Voltage: 180-240V
 CCT: 2700-5700K
 CRI: 90
 Beam Angle: 10° / 24° / 36°
 Tilting Angle: 90°

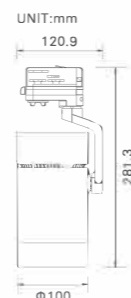

Beam angle

TX-1512SW11A-2757V33-01H90 30W

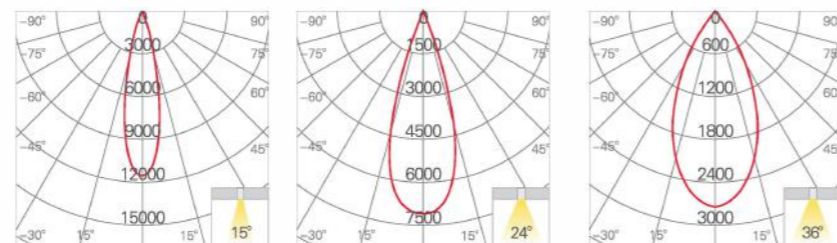

Colors



LP-1009-40

Lamp: TX-2548SW21A
 -2757V33-01H90
 Power: 40W
 Lumens: 78-90LM/W
 Voltage: 180-240V
 CCT: 2700-5700K
 CRI: 90
 Beam Angle: 10° / 24° / 36°
 Tilting Angle: 90°

LP-1009-50

Lamp: TX-2548SW21A
 -2757V33-01H90
 Power: 50W
 Lumens: 78-90LM/W
 Voltage: 180-240V
 CCT: 2700-5700K
 CRI: 90
 Beam Angle: 10° / 24° / 36°
 Tilting Angle: 90°

LP-1009-111

Lamp: ES111
 Lumens: 78-90LM/W
 Voltage: 180-240V
 CRI: 90
 Tilting Angle: 90°

LP-1009-60

Lamp: TX-2548SW21A
 -2757V33-01H90
 Power: 60W
 Lumens: 78-90LM/W
 Voltage: 180-240V
 CCT: 2700-5700K
 CRI: 90
 Beam Angle: 10° / 24° / 36°
 Tilting Angle: 90°

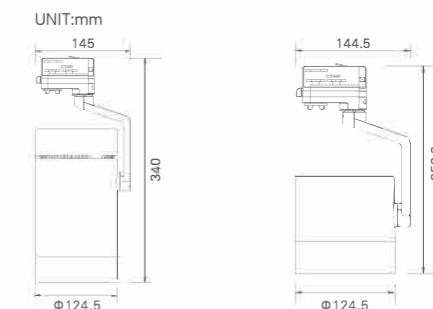

Beam angle

TX-1512SW11A-2757V33-01H90 50W

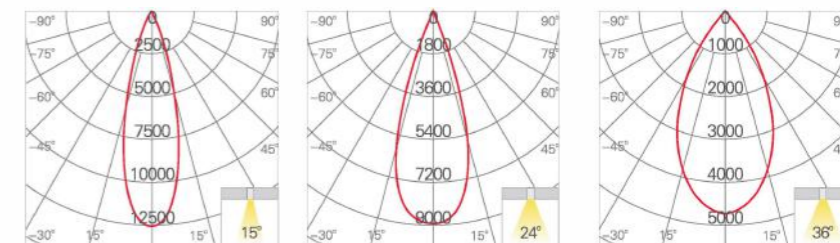

Colors

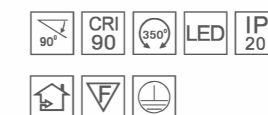



LP-S1040-10

Lamp: TOYONIA,Y3ES
Power: 10W
Lumens: 78~90LM/W
Voltage: 180~240V
CCT: 2700~5000K
CRI: 90
Beam Angle: 15° ~ 50°
Tilting Angle: 35°
CUT-OUT: 120X120mm

LP-S1040-15

Lamp: TOYONIA,Y3ES
Power: 15W
Lumens: 78~90LM/W
Voltage: 180~240V
CCT: 2700~5000K
CRI: 90
Beam Angle: 15° ~ 50°
Tilting Angle: 35°
CUT-OUT: 120X120mm

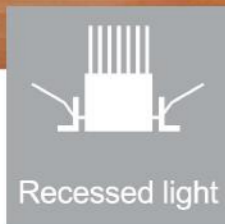
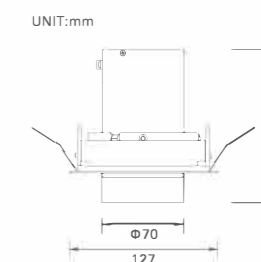

Recessed light

Hera series



Beam angle

TOYONIA.Y3ES 10W

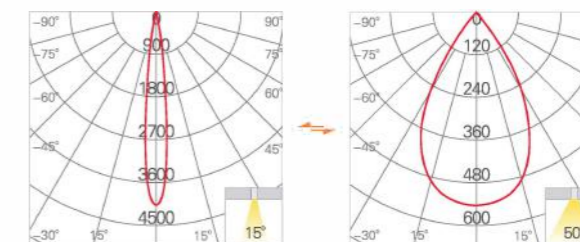

TOYONIA.Y3ES 15W

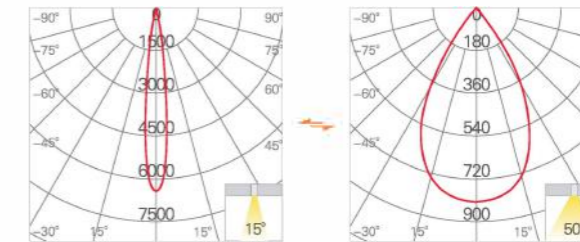

Colors





LP-F1040-10

Lamp: TOYONIA.Y3ES
Power: 10W
Lumens: 78~90LM/W
Voltage: 180~240V
CCT: 2700~5000K
CRI: 90
Beam Angle: 15° ~ 50°
Tilting Angle: 35°
CUT-OUT: 115X115mm

LP-F1040-15

Lamp: TOYONIA.Y3ES
Power: 15W
Lumens: 78~90LM/W
Voltage: 180~240V
CCT: 2700~5000K
CRI: 90
Beam Angle: 15° ~ 50°
Tilting Angle: 35°
CUT-OUT: 115X115mm

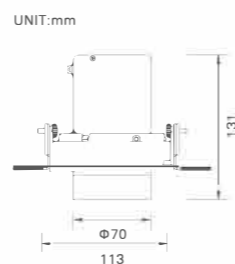

LP-R1040-10

Lamp: TOYONIA.Y3ES
Power: 10W
Lumens: 78~90LM/W
Voltage: 180~240V
CCT: 2700~5000K
CRI: 90
Beam Angle: 15° ~ 50°
Tilting Angle: 35°
CUT-OUT: Φ118mm

LP-R1040-15

Lamp: TOYONIA.Y3ES
Power: 15W
Lumens: 78~90LM/W
Voltage: 180~240V
CCT: 2700~5000K
CRI: 90
Beam Angle: 15° ~ 50°
Tilting Angle: 35°
CUT-OUT: Φ118mm

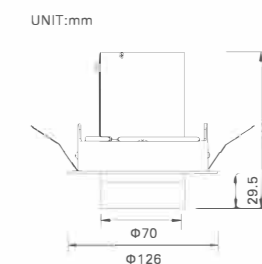

Beam angle

TOYONIA.Y3ES 10W

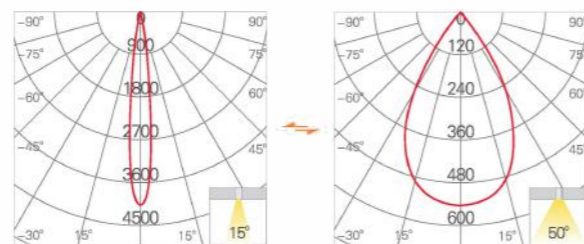

TOYONIA.Y3ES 15W

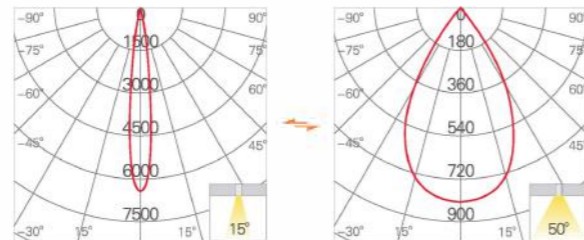

Colors



Beam angle

TOYONIA.Y3ES 10W

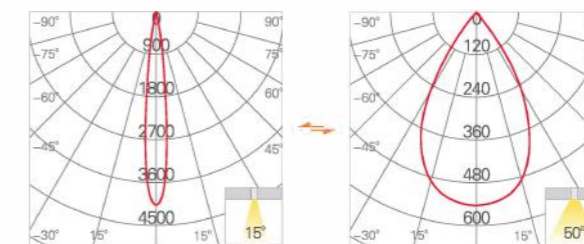

TOYONIA.Y3ES 15W

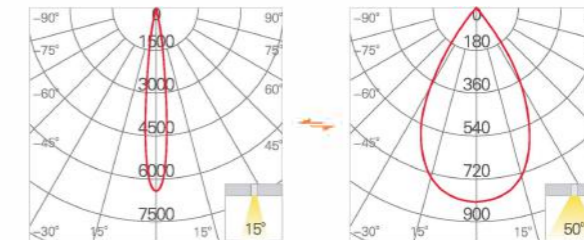

Colors





LP-Y1040-10

Lamp: TOYONIA.Y3ES
Power: 10W
Lumens: 78~90LM/W
Voltage: 180~240V
CCT: 2700~5000K
CRI: 90
Beam Angle: 15° ~50°
Tilting Angle: 35°
CUT-OUT: Φ117mm

LP-Y1040-15

Lamp: TOYONIA.Y3ES
Power: 15W
Lumens: 78~90LM/W
Voltage: 180~240V
CCT: 2700~5000K
CRI: 90
Beam Angle: 15° ~50°
Tilting Angle: 35°
CUT-OUT: Φ117mm

UNIT:mm

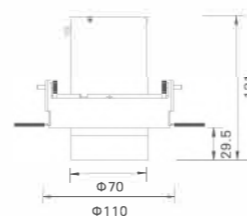

Combi



Beam angle

TOYONIA.Y3ES 10W

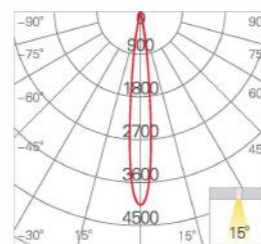

TOYONIA.Y3ES 15W

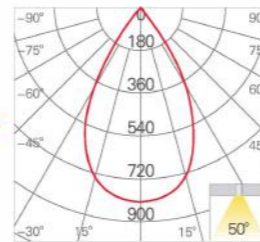
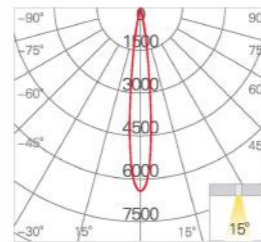

Colors



Black



Silver





All products of
Combi series



Core part

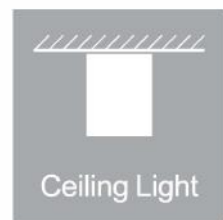

Ceiling Light



Pendant

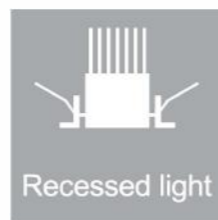

Recessed light

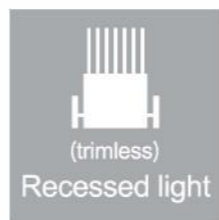

(trimless)
Recessed light



Circular

Square

Specification Of Core Part



LP-GU10
GU10
Φ82mm

LP-S
COB 10W
Φ82mm

LP-M
COB 20W
Φ107mm

LP-L
COB 30W
Φ134mm



35°

Two positions of assembly

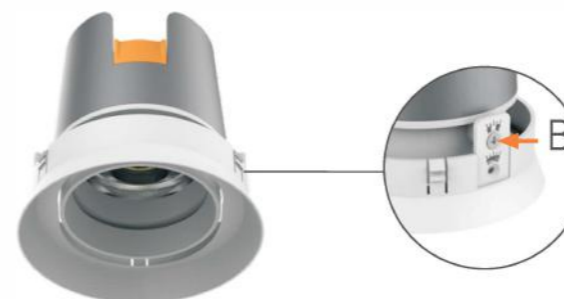
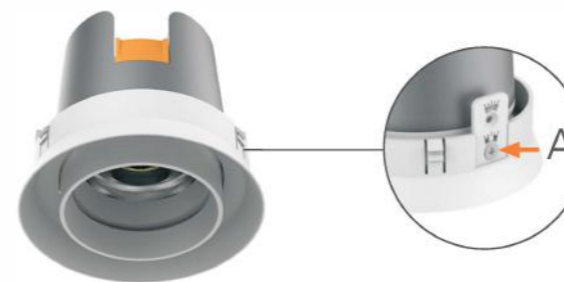

Accessory: Cross-louvre, honeycomb



Cross-louvre



Honey Comb

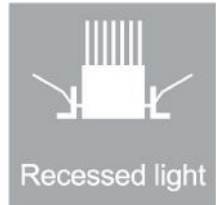

Recessed light

Combi Recessed Light



Assemble two or three in a straight line

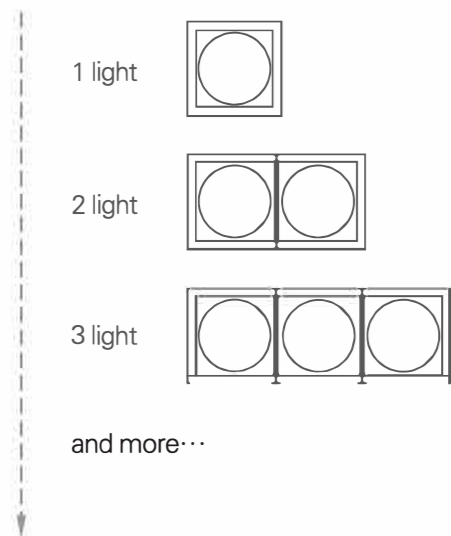

Connector :



C-S

C-L

C-I

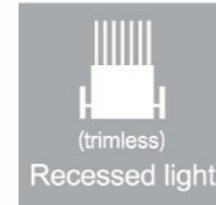

(trimless)
Recessed light

Combi Recessed Light



Arbitrary permutations and combinations

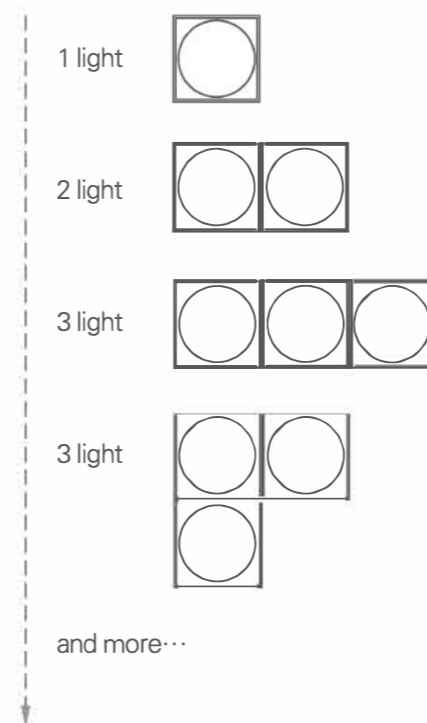

Connector :



C-S

C-L

C-I

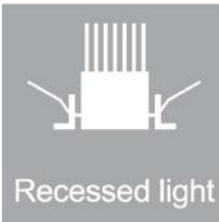

Combi series



LP-S1042-GU10
Lamp: GU10
CUT-OUT :96X96mm



LP-S1041-10
COB 10W
CUT-OUT :96X96mm



LP-S1041-20
COB 20W
CUT-OUT :121X121mm



LP-S1041-30
COB 30W
CUT-OUT :149X149mm



LP-F1042-GU10
Lamp: GU10
CUT-OUT :92X92mm



LP-F1041-10
COB 10W
CUT-OUT :92X92mm



LP-F1041-20
COB 20W
CUT-OUT :117X117mm



LP-F1041-30
COB 30W
CUT-OUT :146X146mm



LP-R1042-GU10
Lamp: GU10
CUT-OUT :Φ94mm



LP-R1041-10
COB 10W
CUT-OUT :Φ94mm



LP-R1041-20
COB 20W
CUT-OUT :Φ118mm



LP-R1041-30
COB 30W
CUT-OUT :Φ145mm



LP-Y1042-GU10
Lamp: GU10
CUT-OUT :Φ94mm



LP-Y1041-10
COB 10W
CUT-OUT :Φ94mm



LP-Y1041-20
COB 20W
CUT-OUT :Φ117mm



LP-Y1041-30
COB 30W
CUT-OUT :Φ146mm

Combi series



Easy Installation

Standar Part



Cross-louvre



Honey Comb





LP-S1042-GU10

Lamp: GU10
Lumens: 78-90LMW
Voltage: 180-240V
CRI: 90
Tilting Angle: 35°
CUT-OUT: 96X96mm

LP-S1041-10

Lamp: PHILIPS
Power: 10W
Lumens: 78-90LMW
Voltage: 180-240V
CCT: 3000K
CRI: 90
Beam Angle: 15° / 24° / 36°
Tilting Angle: 35°
CUT-OUT: 96X96mm

UNIT:mm

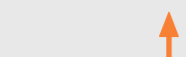
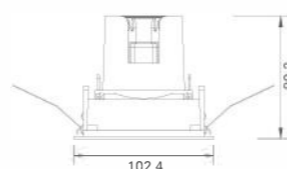
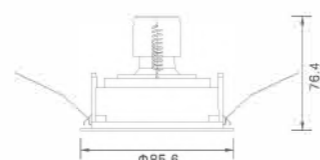

Accessory: Cross-louvre, honeycomb

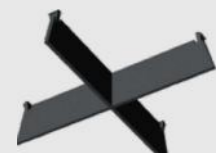

Cross-louvre



Honey Comb

Beam angle PHILIPS 10W

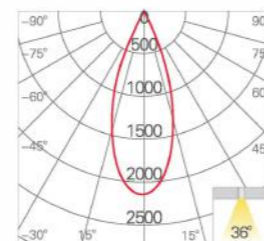
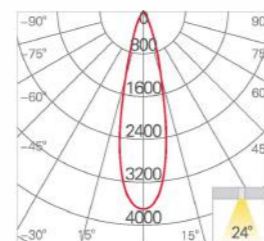

Colors



Black



White

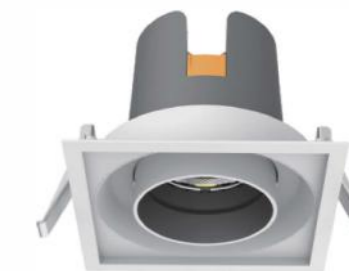

LP-S1041-20

Lamp: PHILIPS
Power: 20W
Lumens: 78-90LMW
Voltage: 180-240V
CCT: 3000K
CRI: 90
Beam Angle: 15° / 24° / 36°
Tilting Angle: 35°
CUT-OUT: 121X121mm

LP-S1041-30

Lamp: PHILIPS
Power: 30W
Lumens: 78-90LMW
Voltage: 180-240V
CCT: 3000K
CRI: 90
Beam Angle: 15° / 24° / 36°
Tilting Angle: 35°
CUT-OUT: 149X149mm

UNIT:mm

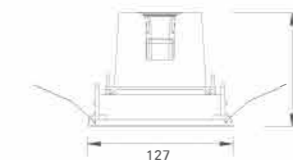

Beam angle PHILIPS 20W

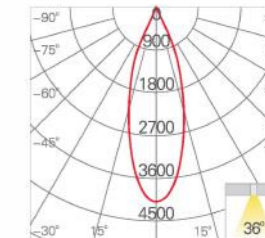
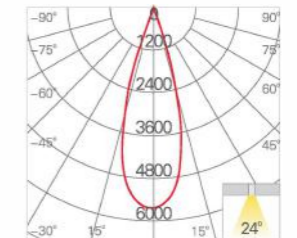
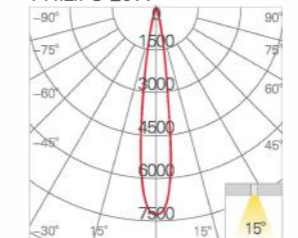

PHILIPS 30W

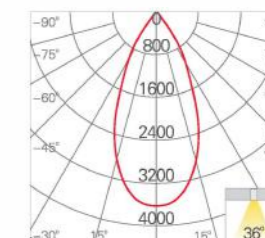
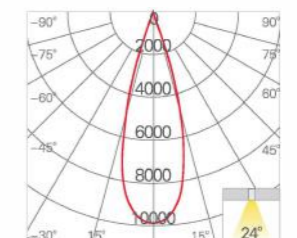
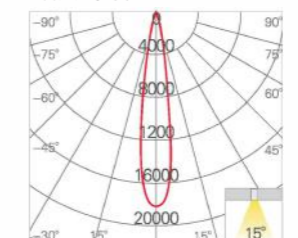

Colors



Black



White





Combi series

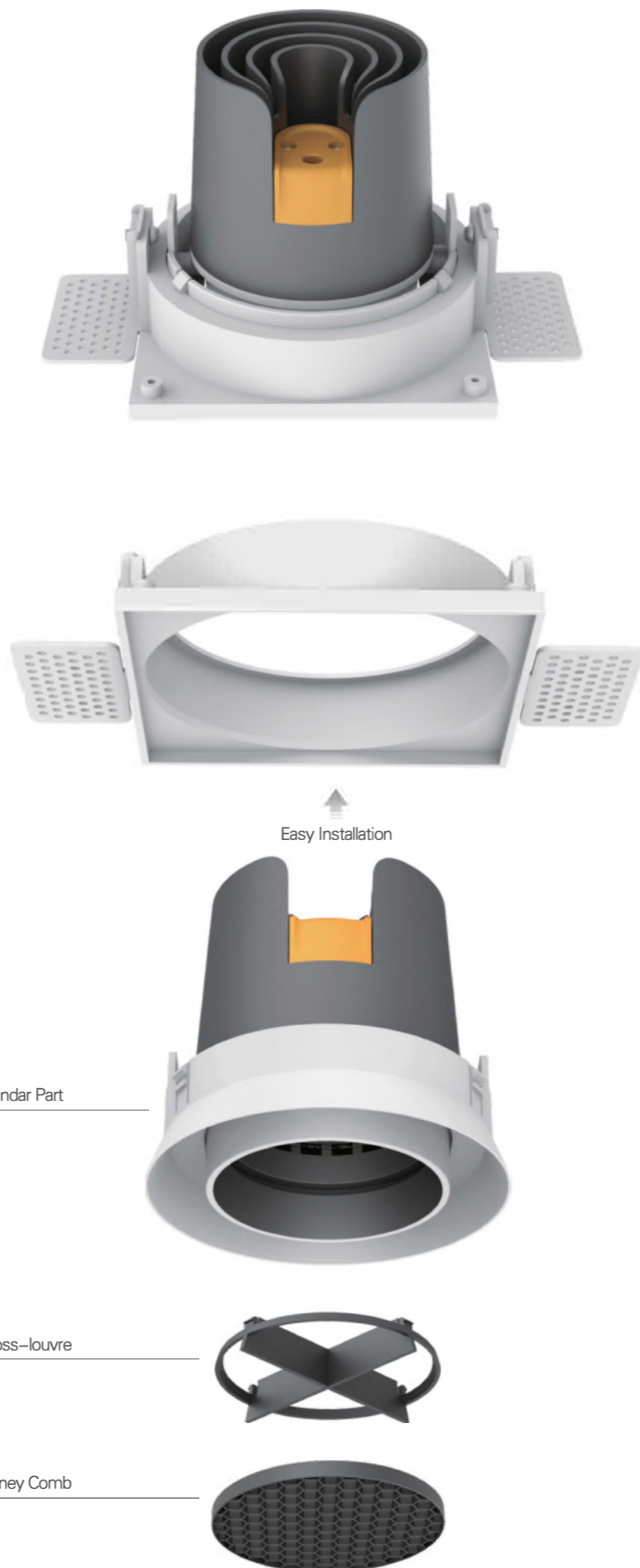

Accessory: Cross-louvre, honeycomb



Cross-louvre



Honey Comb



LP-F1042-GU10

Lamp: GU10
 Lumens: 78-90LM/W
 Voltage: 180-240V
 CRI: 90
 Tilting Angle: 35°
 CUT-OUT: 92X92mm

LP-F1041-10

Lamp: PHILIPS
 Power: 10W
 Lumens: 78-90LM/W
 Voltage: 180-240V
 CCT: 3000K
 CRI: 90
 Beam Angle: 15° / 24° / 36°
 Tilting Angle: 35°
 CUT-OUT: 92X92mm

UNIT:mm

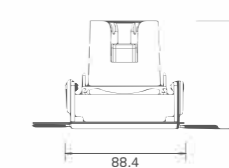
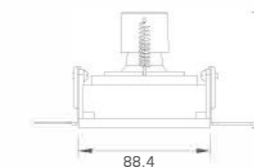

Beam angle PHILIPS 10W

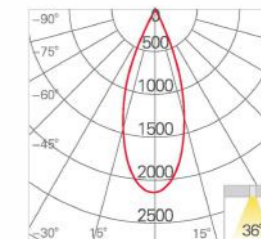
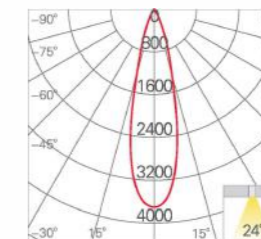

Colors



Black



White





LP-F1041-20

Lamp: PHILIPS
 Power: 20W
 Lumens: 78-90LM/W
 Voltage: 180-240V
 CCT: 3000K
 CRI: 90
 Beam Angle: 15° / 24° / 36°
 Tilting Angle: 35°
 CUT-OUT: 117X117mm

LP-F1041-30

Lamp: PHILIPS
 Power: 30W
 Lumens: 78-90LM/W
 Voltage: 180-240V
 CCT: 3000K
 CRI: 90
 Beam Angle: 15° / 24° / 36°
 Tilting Angle: 35°
 CUT-OUT: 146X146mm

UNIT:mm

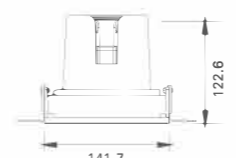
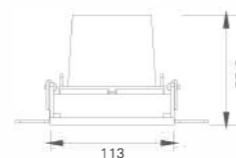

Beam angle

PHILIPS 20W

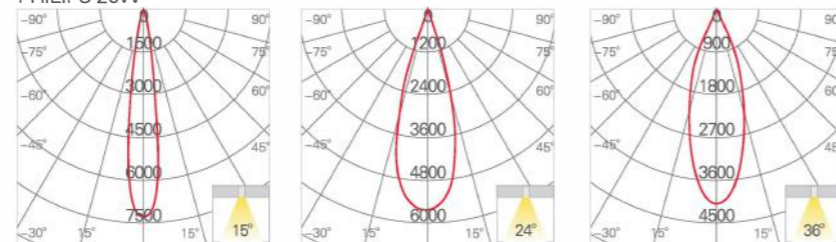

PHILIPS 30W

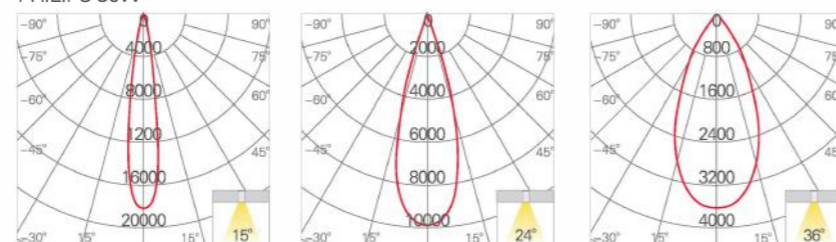

Colors



Black



White

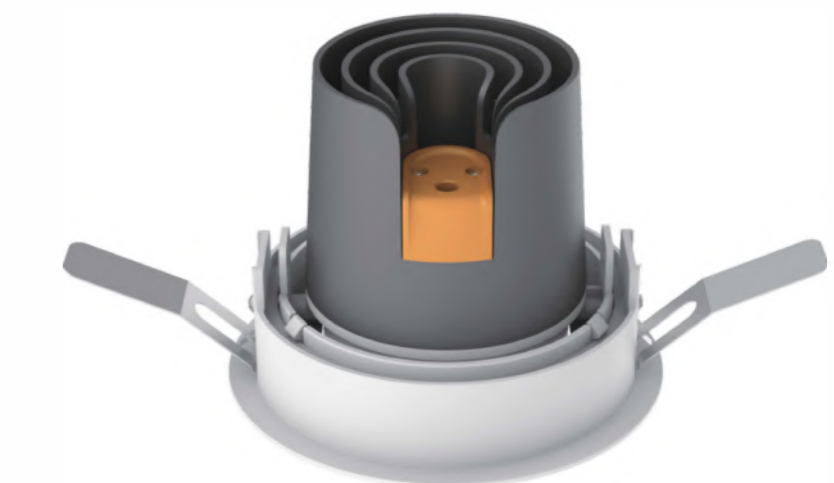
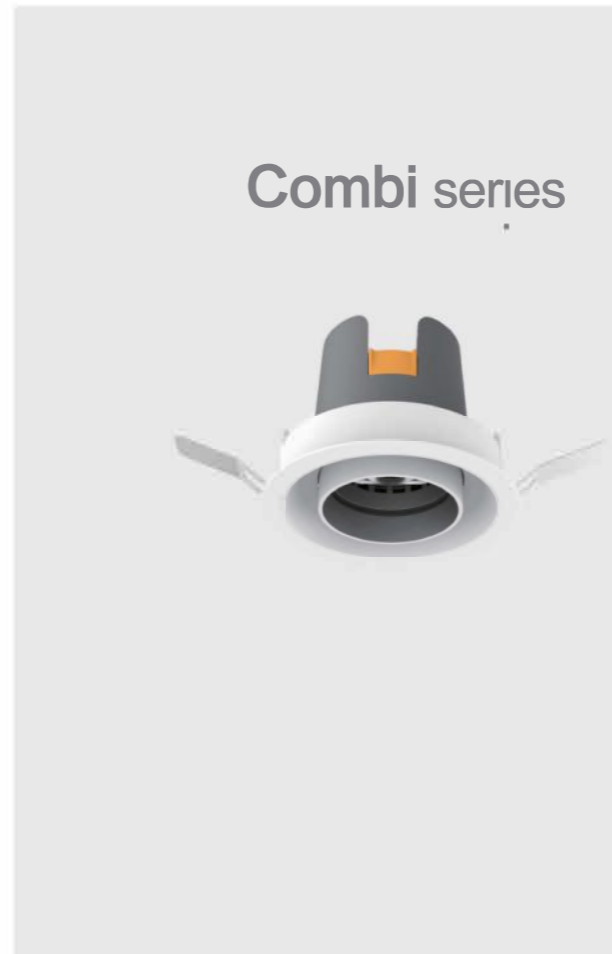

Easy Installation

Standar Part



Cross-louvre



Honey Comb





LP-R1042-GU10

Lamp: GU10
Lumens: 78~90LMW
Voltage: 180~240V
CRI: 90
Tilting Angle: 35°
CUT-OUT: Φ94mm

LP-R1041-10

Lamp: PHILIPS
Power: 10W
Lumens: 78~90LMW
Voltage: 180~240V
CCT: 3000K
CRI: 90
Beam Angle: 15° / 24° / 36°
Tilting Angle: 35°
CUT-OUT: Φ94mm

UNIT:mm

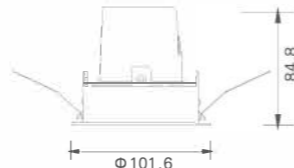
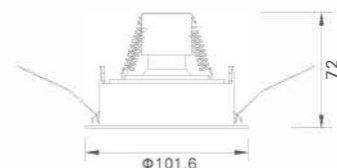

Beam angle PHILIPS 10W

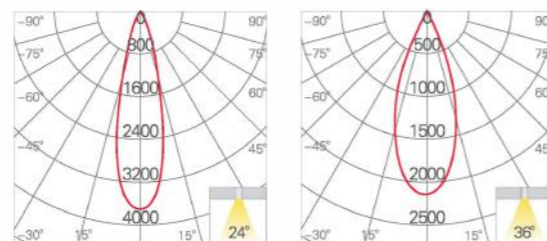

Colors



Accessory: Cross-louvre, honeycomb



Cross-louvre



Honey Comb



LP-R1041-20

Lamp: PHILIPS
Power: 20W
Lumens: 78~90LMW
Voltage: 180~240V
CCT: 3000K
CRI: 90
Beam Angle: 15° / 24° / 36°
Tilting Angle: 35°
CUT-OUT: Φ118mm

LP-R1041-30

Lamp: PHILIPS
Power: 30W
Lumens: 78~90LMW
Voltage: 180~240V
CCT: 3000K
CRI: 90
Beam Angle: 15° / 24° / 36°
Tilting Angle: 35°
CUT-OUT: Φ145mm

UNIT:mm

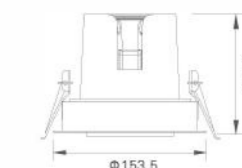
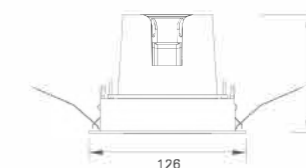

Beam angle PHILIPS 20W

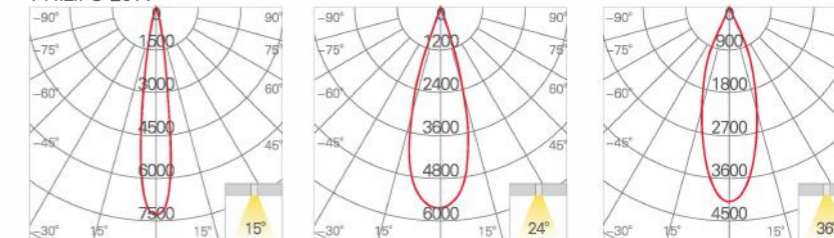

PHILIPS 30W

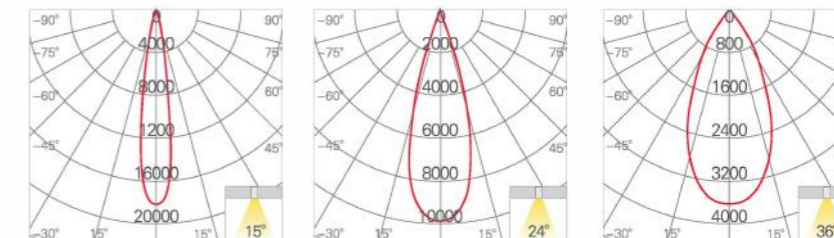

Colors





Combi series



Easy Installation

Standar Part



Cross-louvre



Honey Comb



Accessory: Cross-louvre, honeycomb



Cross-louvre



Honey Comb



LP-Y1041-10

Lamp: PHILIPS
Power: 10W
Lumens: 78-90LMW
Voltage: 180-240V
CCT: 3000K
CRI: 90
Beam Angle: 15° / 24° / 36°
Tilting Angle: 35°
CUT-OUT: Φ94mm

LP-Y1042-GU10

Lamp: GU10
Lumens: 78-90LMW
Voltage: 180-240V
CRI: 90
Tilting Angle: 35°
CUT-OUT: Φ94mm

UNIT:mm

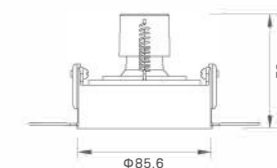
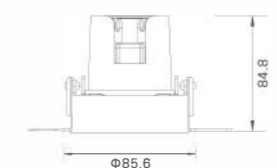

Beam angle

PHILIPS 10W

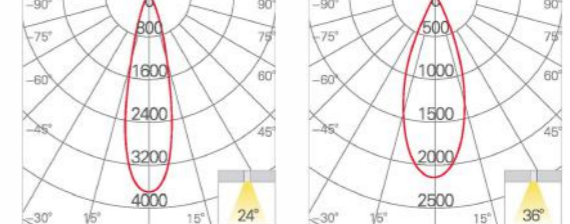

Colors



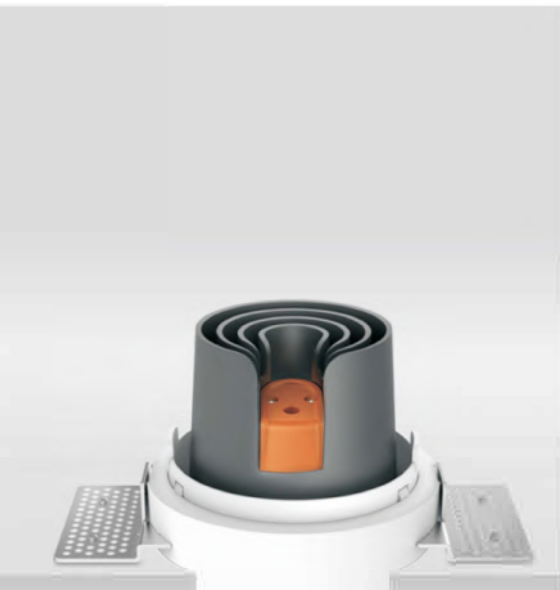

LP-Y1041-20

Lamp: PHILIPS
 Power: 20W
 Lumens: 78-90LM/W
 Voltage: 180-240V
 CCT: 3000K
 CRI: 90
 Beam Angle: 15° / 24° / 36°
 Tilting Angle: 35°
 CUT-OUT: Φ117mm

LP-Y1041-30

Lamp: PHILIPS
 Power: 30W
 Lumens: 78-90LM/W
 Voltage: 180-240V
 CCT: 3000K
 CRI: 90
 Beam Angle: 15° / 24° / 36°
 Tilting Angle: 35°
 CUT-OUT: Φ146mm

UNIT:mm

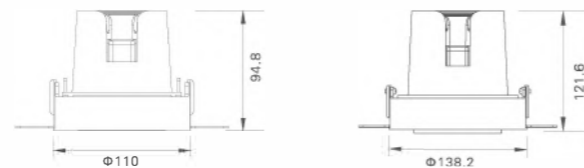

Beam angle

PHILIPS 20W

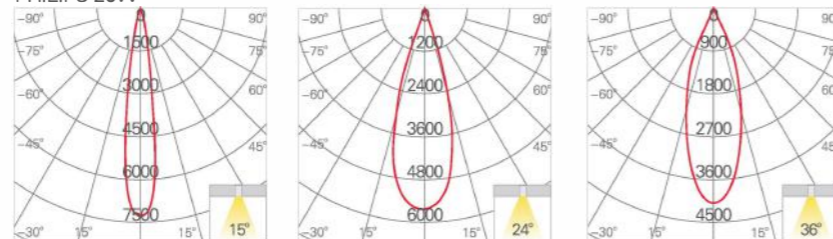

PHILIPS 30W

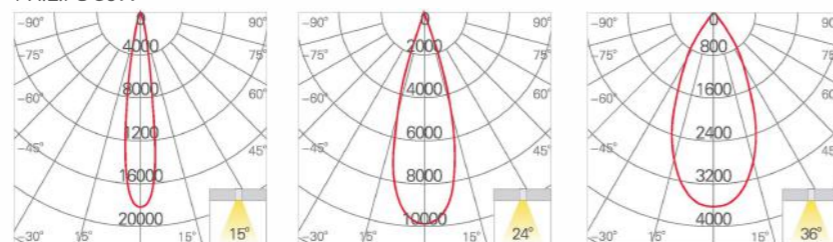

Colors



Black

White

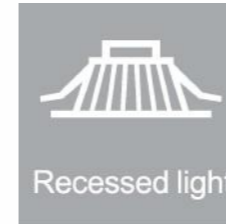

Recessed light

Combination series



LP-T0935-1X10
COB 10W



LP-T0935A-1X10
COB 10W



LP-T0935-2 x 10
COB 10WX2
CUT-OUT :181X96mm



LP-T0935-3 x 10
COB 10WX3
CUT-OUT :269X96mm



LP-L0935-2 x 10
COB 10WX2
CUT-OUT :181X92mm



LP-L0935-3 x 10
COB 10WX3
CUT-OUT :269X92mm



LP-L0935A-3 x 10
COB 10WX3
CUT-OUT :181X181X92X92mm



LP-T0935-1X20
COB 20W



LP-T0935A-1X20
COB 20W



LP-T0935-2 x 20
COB 20WX2
CUT-OUT :230X121mm



LP-T0935-3 x 20
COB 20WX3
CUT-OUT :343X121mm



LP-L0935-2 x 20
COB 20WX2
CUT-OUT :230X117mm



LP-L0935-3 x 20
COB 20WX3
CUT-OUT :343X117mm



LP-L0935A-3 x 20
COB 20WX3
CUT-OUT :230X230X117X117mm



LP-T0935-1X30
COB 30W



LP-T0935A-1X30
COB 30W



LP-T0935-2 x 30
COB 30WX2
CUT-OUT :290X149mm



LP-T0935-3 x 30
COB 30WX3
CUT-OUT :430X149mm



LP-L0935-2 x 30
COB 30WX2
CUT-OUT :287X146mm



LP-L0935-3 x 30
COB 30WX3
CUT-OUT :429X146mm



LP-L0935A-3 x 30
COB 30WX3
CUT-OUT :287X287X146X146mm



LP-T0935-1X10

Lamp: PHILIPS
Power: 10W
Lumens: 78-90LM/W
Voltage: 180-240V
CCT: 3000K
CRI: 90
Beam Angle: 15° / 24° / 36°
Tilting Angle: 35°

LP-T0935A-1X10

Lamp: PHILIPS
Power: 10W
Lumens: 78-90LM/W
Voltage: 180-240V
CCT: 3000K
CRI: 90
Beam Angle: 15° / 24° / 36°
Tilting Angle: 35°

UNIT:mm

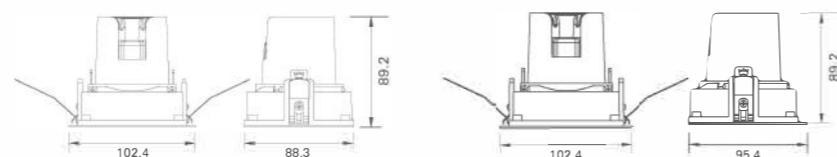

Beam angle
PHILIPS 10W

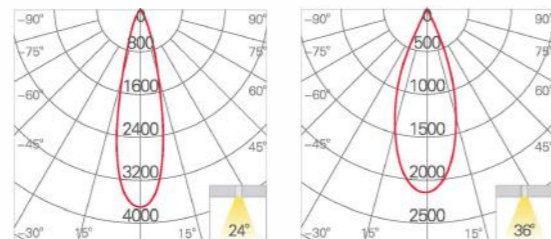

Colors



Black

White



LP-T0935-2x10

Lamp: PHILIPS
Power: 10WX2
Lumens: 78-90LM/W
Voltage: 180-240V
CCT: 3000K
CRI: 90
Beam Angle: 15° / 24° / 36°
Tilting Angle: 35°
CUT-OUT: 181X96mm



LP-T0935-3x10

Lamp: PHILIPS
Power: 10WX3
Lumens: 78-90LM/W
Voltage: 180-240V
CCT: 3000K
CRI: 90
Beam Angle: 15° / 24° / 36°
Tilting Angle: 35°
CUT-OUT: 269X96mm

UNIT:mm

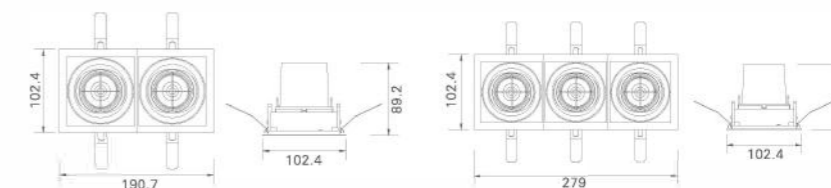

Beam angle
PHILIPS 10W

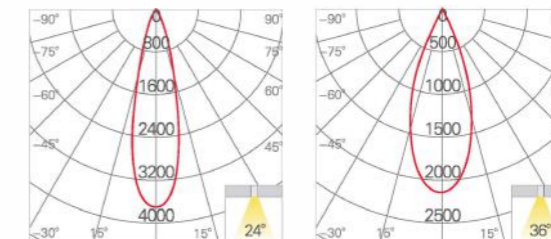

Colors



Black

White



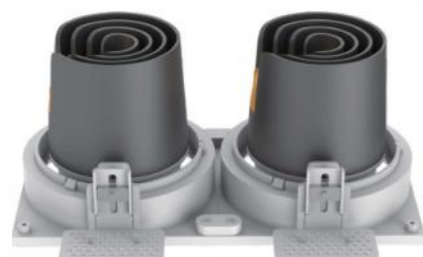

LP-L0935-2X10

Lamp: PHILIPS
 Power: 10WX2
 Lumens: 78-90LM/W
 Voltage: 180-240V
 CCT: 3000K
 CRI: 90
 Beam Angle: 15° / 24° / 36°
 Tilting Angle: 35°
 CUT-OUT: 181X92mm

LP-L0935-3x10

Lamp: PHILIPS
 Power: 10WX3
 Lumens: 78-90LM/W
 Voltage: 180-240V
 CCT: 3000K
 CRI: 90
 Beam Angle: 15° / 24° / 36°
 Tilting Angle: 35°
 CUT-OUT: 269X92mm

UNIT:mm

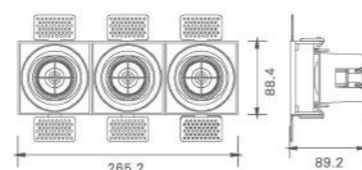
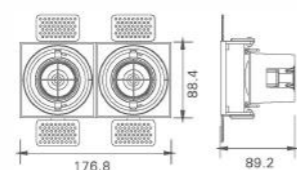

Beam angle

PHILIPS 10W

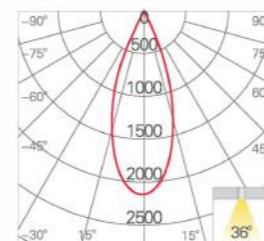
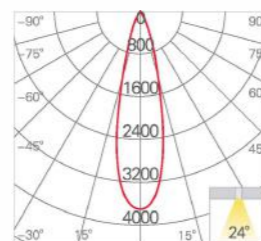

Colors



Black

White

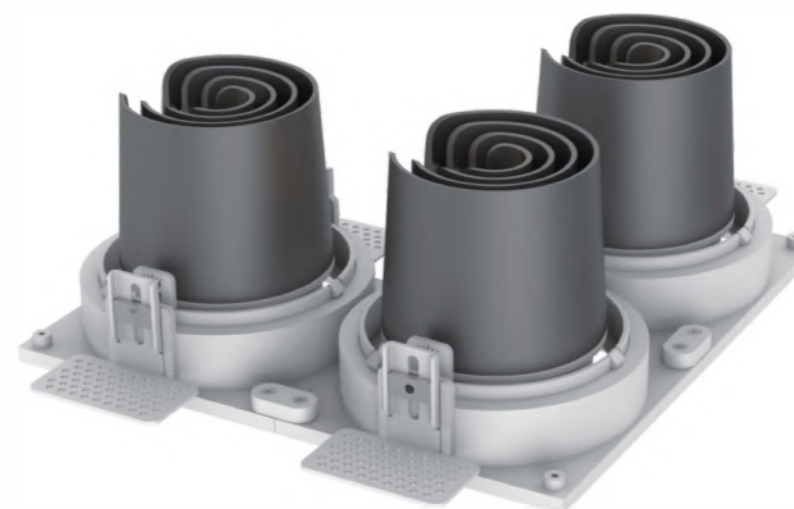

LP-L0935A-3x10

Lamp: PHILIPS
 Power: 10WX3
 Lumens: 78-90LM/W
 Voltage: 180-240V
 CCT: 3000K
 CRI: 90
 Beam Angle: 15° / 24° / 36°
 Tilting Angle: 35°
 CUT-OUT: 181X181X92X92mm

UNIT:mm

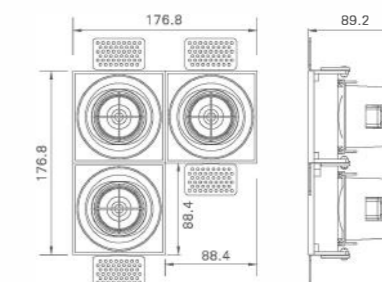

Beam angle

PHILIPS 10W

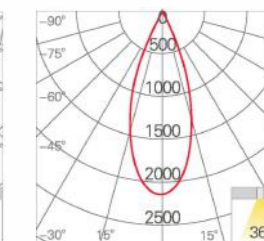
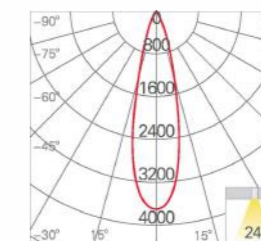

Colors



Black

White

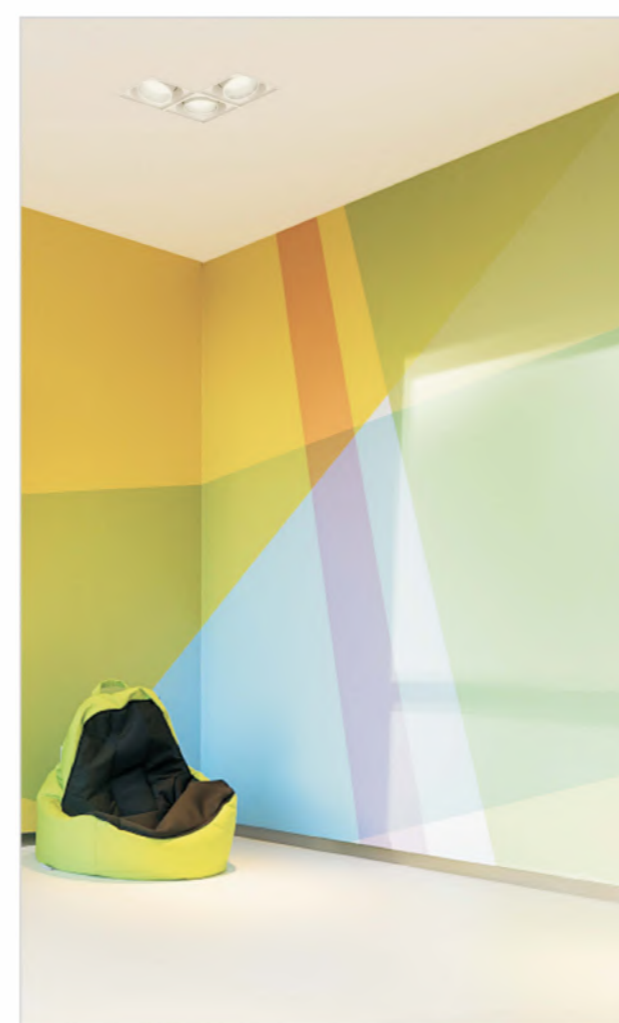



LP-T0935-1X20

Lamp: PHILIPS
 Power: 20W
 Lumens: 78-90LM/W
 Voltage: 180-240V
 CCT: 3000K
 CRI: 90
 Beam Angle: 15° / 24° / 36°
 Tilting Angle: 35°



LP-T0935A-1X20

Lamp: PHILIPS
 Power: 20W
 Lumens: 78-90LM/W
 Voltage: 180-240V
 CCT: 3000K
 CRI: 90
 Beam Angle: 15° / 24° / 36°
 Tilting Angle: 35°



LP-T0935-2x20

Lamp: PHILIPS
 Power: 20WX2
 Lumens: 78-90LM/W
 Voltage: 180-240V
 CCT: 3000K
 CRI: 90
 Beam Angle: 15° / 24° / 36°
 Tilting Angle: 35°
 CUT-OUT: 230X121mm

LP-T0935-3x20

Lamp: PHILIPS
 Power: 20WX3
 Lumens: 78-90LM/W
 Voltage: 180-240V
 CCT: 3000K
 CRI: 90
 Beam Angle: 15° / 24° / 36°
 Tilting Angle: 35°
 CUT-OUT: 343X121mm

UNIT:mm

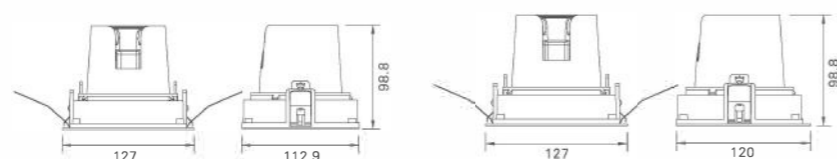

UNIT:mm

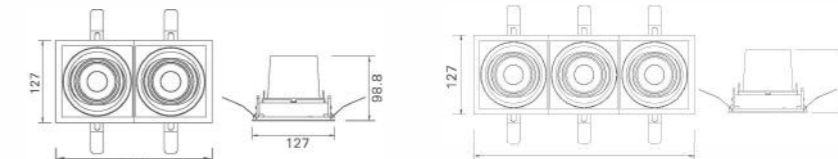

Beam angle

PHILIPS 20W

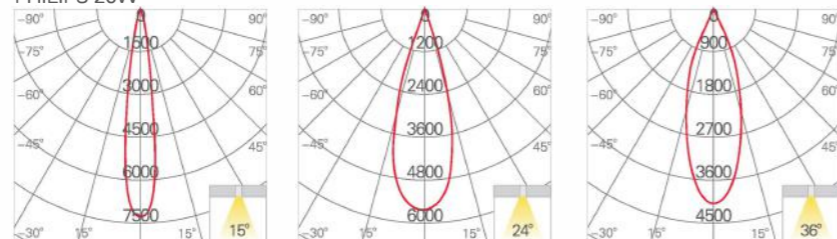

Beam angle

PHILIPS 20W

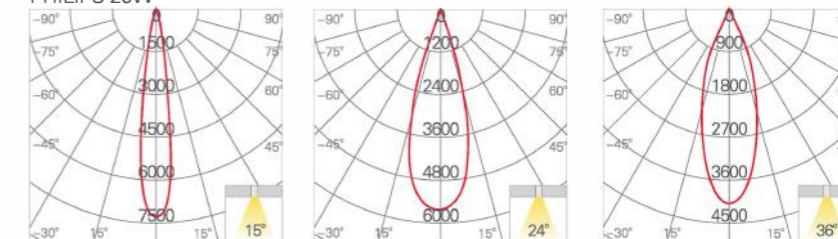

Colors



Black

White



Colors



Black

White



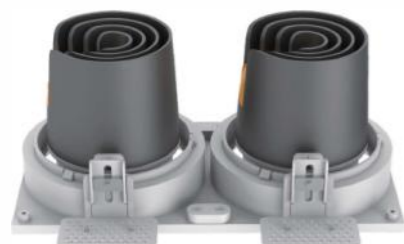

LP-L0935-2X20

Lamp: PHILIPS
 Power: 20WX2
 Lumens: 78-90LM/W
 Voltage: 180-240V
 CCT: 3000K
 CRI: 90
 Beam Angle: 15° / 24° / 36°
 Tilting Angle: 35°
 CUT-OUT: 230X117mm

LP-L0935-3x20

Lamp: PHILIPS
 Power: 20WX3
 Lumens: 78-90LM/W
 Voltage: 180-240V
 CCT: 3000K
 CRI: 90
 Beam Angle: 15° / 24° / 36°
 Tilting Angle: 35°
 CUT-OUT: 343X117mm

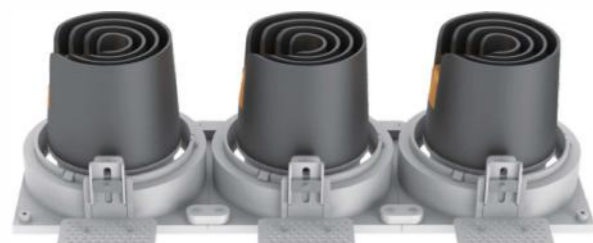

UNIT:mm

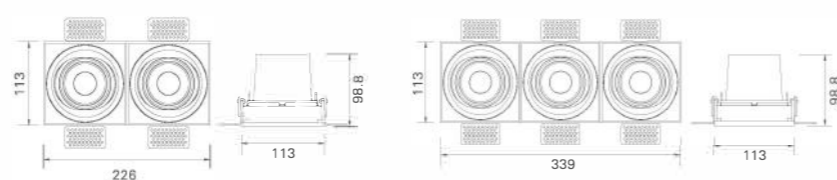

Beam angle

PHILIPS 20W

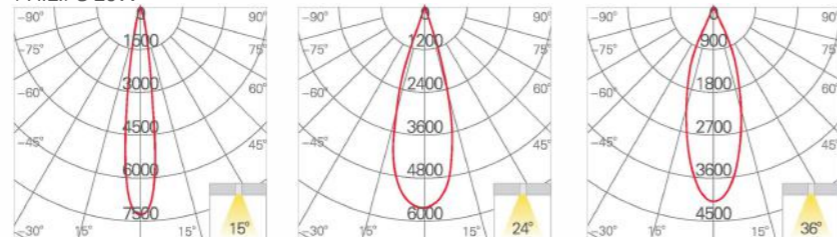

Colors



Black



White

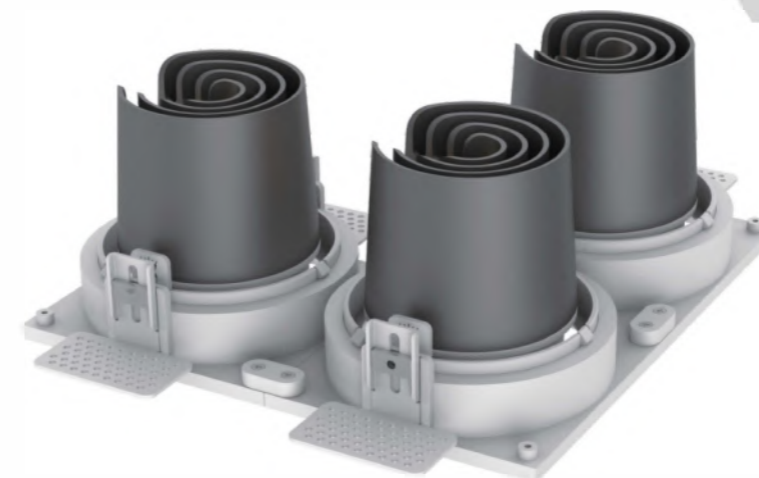

LP-L0935A-3x20

Lamp: PHILIPS
 Power: 20WX3
 Lumens: 78-90LM/W
 Voltage: 180-240V
 CCT: 3000K
 CRI: 90
 Beam Angle: 15° / 24° / 36°
 Tilting Angle: 35°
 CUT-OUT: 230X230X117X117

UNIT:mm

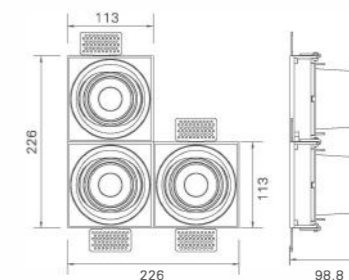

Beam angle

PHILIPS 20W

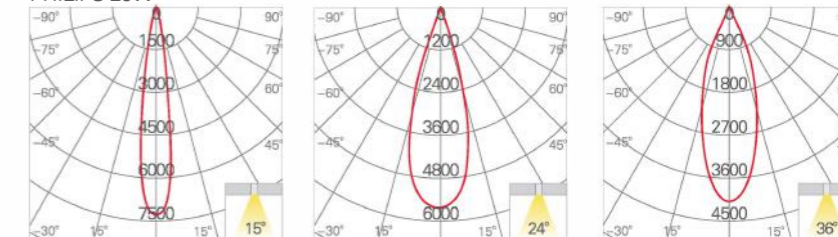

Colors



Black



White





LP-T0935-1X30

Lamp: PHILIPS
 Power: 30W
 Lumens: 78-90LM/W
 Voltage: 180-240V
 CCT: 3000K
 CRI: 90
 Beam Angle: 15° / 24° / 36°
 Tilting Angle: 35°



LP-T0935A-1X30

Lamp: PHILIPS
 Power: 30W
 Lumens: 78-90LM/W
 Voltage: 180-240V
 CCT: 3000K
 CRI: 90
 Beam Angle: 15° / 24° / 36°
 Tilting Angle: 35°

UNIT:mm

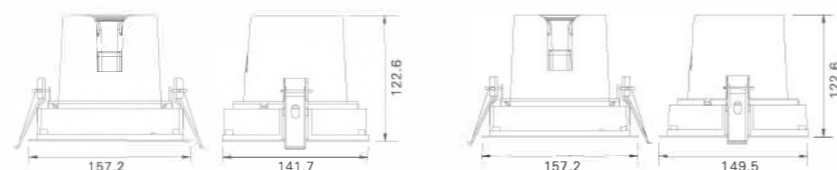

Beam angle PHILIPS 30W

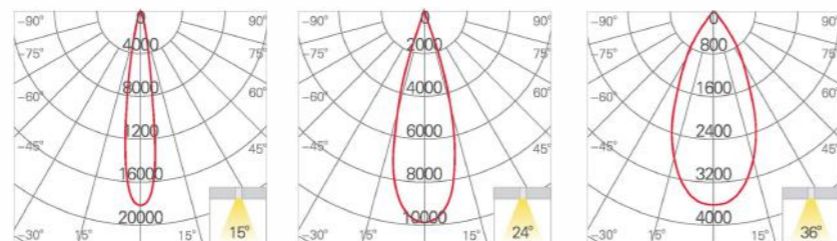

Colors



LP-T0935-2x30

Lamp: PHILIPS
 Power: 30WX2
 Lumens: 78-90LM/W
 Voltage: 180-240V
 CCT: 3000K
 CRI: 90
 Beam Angle: 15° / 24° / 36°
 Tilting Angle: 35°
 CUT-OUT: 290X149mm

LP-T0935-3x30

Lamp: PHILIPS
 Power: 30WX3
 Lumens: 78-90LM/W
 Voltage: 180-240V
 CCT: 3000K
 CRI: 90
 Beam Angle: 15° / 24° / 36°
 Tilting Angle: 35°
 CUT-OUT: 430X149mm

UNIT:mm

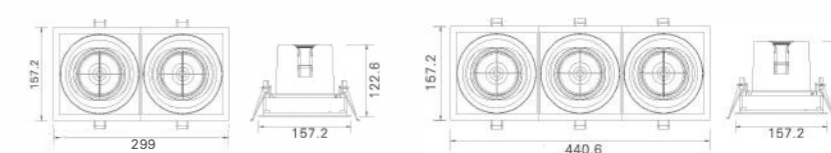

Beam angle PHILIPS 30W

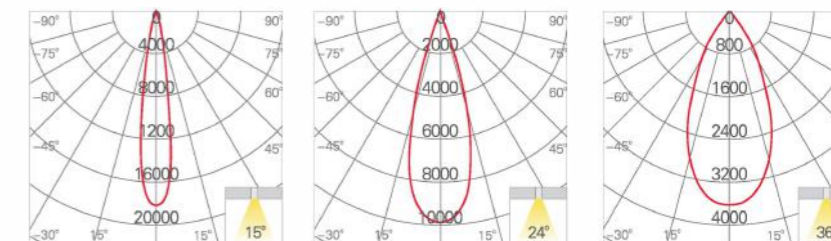

Colors



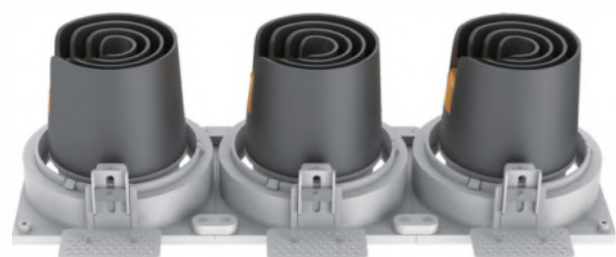
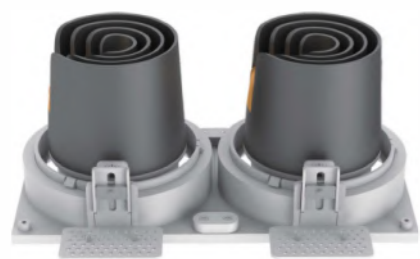

LP-L0935-2X30

Lamp: PHILIPS
Power: 30WX2
Lumens: 78~90LM/W
Voltage: 180~240V
CCT: 3000K
CRI: 90
Beam Angle: 15° / 24° / 36°
Tilting Angle: 35°
CUT-OUT: 287X146mm

LP-L0935-3x30

Lamp: PHILIPS
Power: 30WX3
Lumens: 78~90LM/W
Voltage: 180~240V
CCT: 3000K
CRI: 90
Beam Angle: 15° / 24° / 36°
Tilting Angle: 35°
CUT-OUT: 429X146mm

UNIT:mm

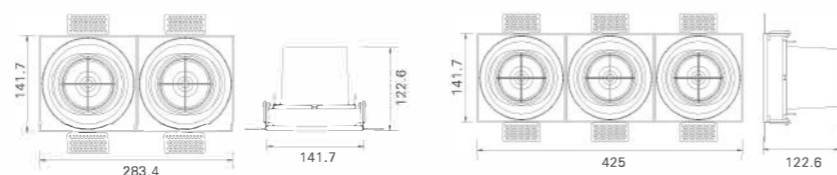

Beam angle
PHILIPS 30W

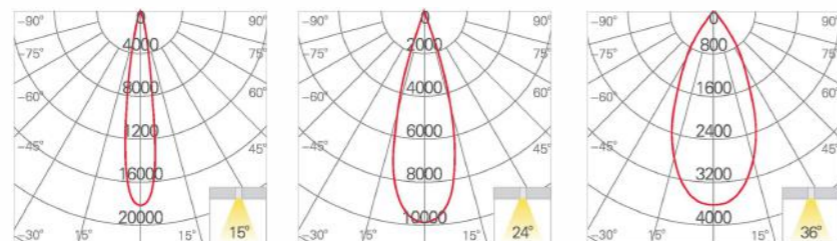

Colors



Black



White

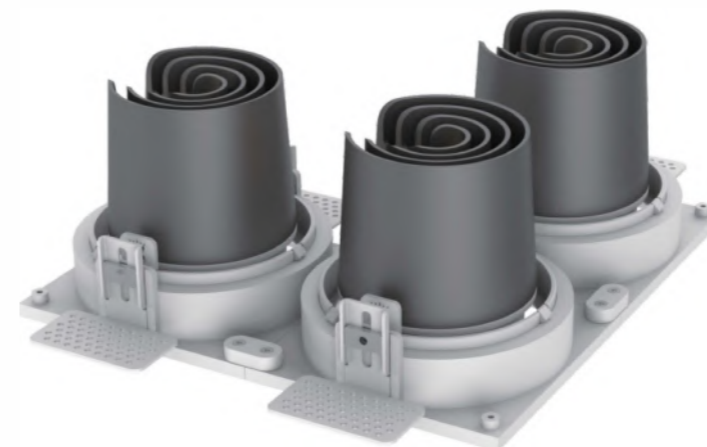

LP-L0935A-3x30

Lamp: PHILIPS
Power: 30WX3
Lumens: 78~90LM/W
Voltage: 180~240V
CCT: 3000K
CRI: 90
Beam Angle: 15° / 24° / 36°
Tilting Angle: 35°
CUT-OUT: 287X287X146X146mm

UNIT:mm

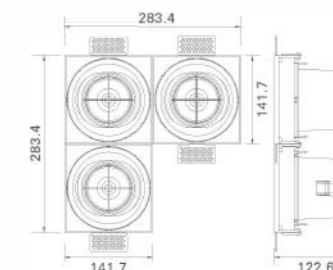

Beam angle
PHILIPS 30W

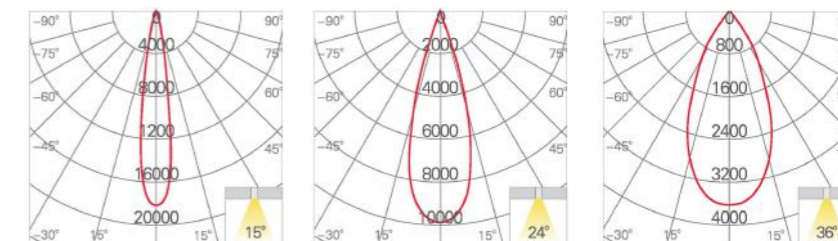

Colors



Black



White



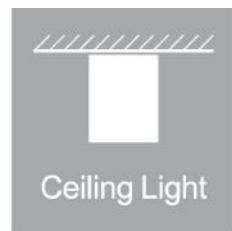

Ceiling Light

Combi Surface-mounted Light



LP-S0316-10
COB 10W
100X100XH:150mm



LP-S0317-10
COB 10W
Φ93XH:150mm



LP-S0316-20
COB 20W
120X120XH:150mm



LP-S0317-20
COB 20W
Φ128XH:150mm



LP-S0316-30
COB 30W
150X150XH:180mm



LP-S0317-30
COB 30W
Φ161XH:180mm

Arbitrary permutations and combinations

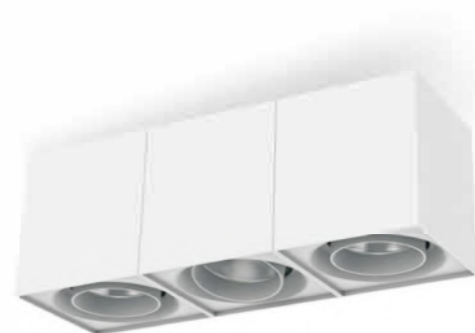

LP-S0316-10

Lamp: PHILIPS
Power: 10W
Lumens: 78-90LM/W
Voltage: 180-240V
CCT: 3000K
CRI: 90
Beam Angle: 15° / 24° / 36°
Tilting Angle: 35°

LP-S0317-10

Lamp: PHILIPS
Power: 10W
Lumens: 78-90LM/W
Voltage: 180-240V
CCT: 3000K
CRI: 90
Beam Angle: 15° / 24° / 36°
Tilting Angle: 35°

UNIT:mm

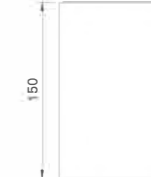
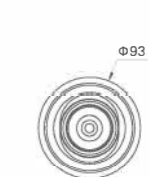
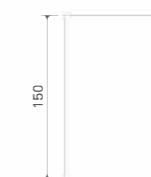
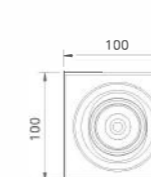

Beam angle PHILIPS 10W

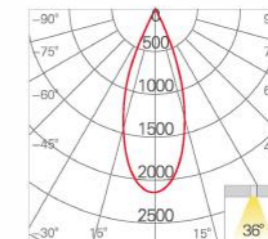
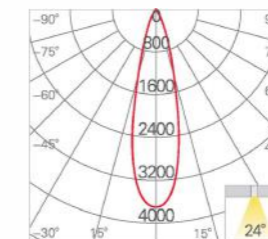

Colors



Black



White





LP-S0316-20

Lamp: PHILIPS
Power: 20W
Lumens: 78~90LM/W
Voltage: 180~240V
CCT: 3000K
CRI: 90
Beam Angle: 15° / 24° / 36°
Tilting Angle: 35°

LP-S0317-20

Lamp: PHILIPS
Power: 20W
Lumens: 78~90LM/W
Voltage: 180~240V
CCT: 3000K
CRI: 90
Beam Angle: 15° / 24° / 36°
Tilting Angle: 35°

UNIT:mm

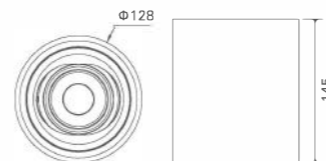
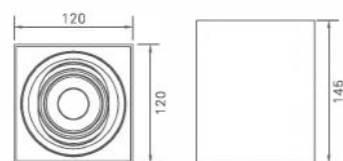

Beam angle

PHILIPS 20W

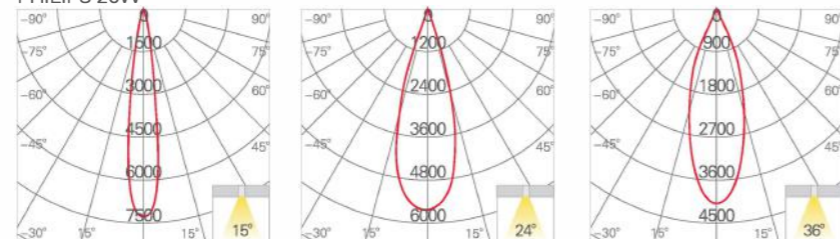

Colors

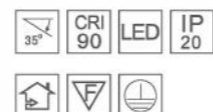

35°



LP-S0316-30

Lamp: PHILIPS
Power: 30W
Lumens: 78~90LM/W
Voltage: 180~240V
CCT: 3000K
CRI: 90
Beam Angle: 15° / 24° / 36°
Tilting Angle: 35°

LP-S0317-30

Lamp: PHILIPS
Power: 30W
Lumens: 78~90LM/W
Voltage: 180~240V
CCT: 3000K
CRI: 90
Beam Angle: 15° / 24° / 36°
Tilting Angle: 35°

UNIT:mm

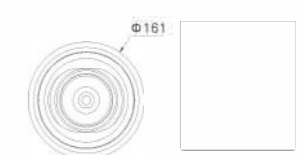
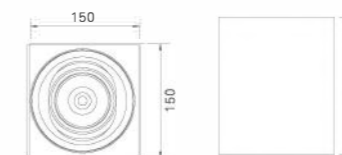

Beam angle

PHILIPS 30W

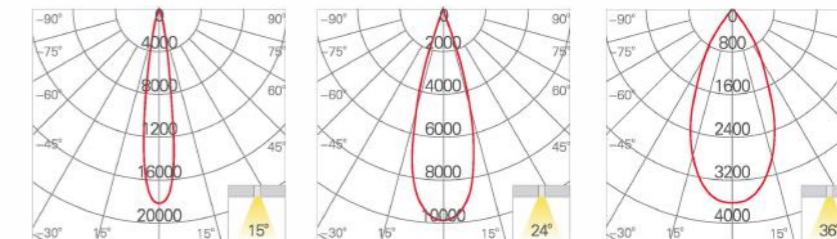

Colors



35°



Pendant

Combi Pendant



LP-D0316-10
COB 10W
100X100XH:150mm



LP-D0317-10
COB 10W
Φ93XH:150mm



LP-D0316-20
COB 20W
120X120XH:150mm



LP-D0317-20
COB 20W
Φ128XH:150mm



LP-D0316-30
COB 30W
150X150XH:180mm



LP-D0317-30
COB 30W
Φ161XH:180mm

Combi series



Easy Installation

Standar Part



Cross-louvre



Honey Comb





Combi series



Easy Installation



Standar Part



Cross-louvre



Honey Comb



LP-D0316-10

Lamp: PHILIPS
Power: 10W
Lumens: 78-90LM/W
Voltage: 180-240V
CCT: 3000K
CRI: 90
Beam Angle: 15° / 24° / 36°
Tilting Angle: 35°



LP-D0317-10

Lamp: PHILIPS
Power: 10W
Lumens: 78-90LM/W
Voltage: 180-240V
CCT: 3000K
CRI: 90
Beam Angle: 15° / 24° / 36°
Tilting Angle: 35°

UNIT:mm



Beam angle PHILIPS 10W

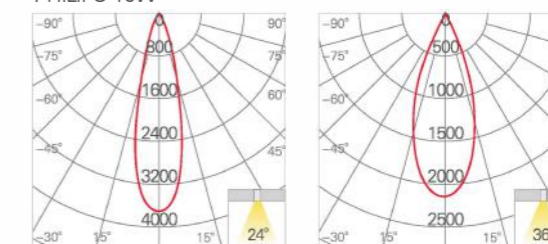

Colors





LP-D0316-20

Lamp: PHILIPS
Power: 20W
Lumens: 78~90LM/W
Voltage: 180~240V
CCT: 3000K
CRI: 90
Beam Angle: 15° / 24° / 36°
Tilting Angle: 35°



LP-D0317-20

Lamp: PHILIPS
Power: 20W
Lumens: 78~90LM/W
Voltage: 180~240V
CCT: 3000K
CRI: 90
Beam Angle: 15° / 24° / 36°
Tilting Angle: 35°

UNIT:mm



Beam angle

PHILIPS 20W

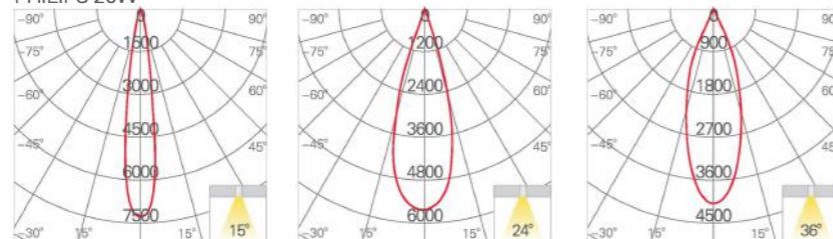

Colors



Black



White

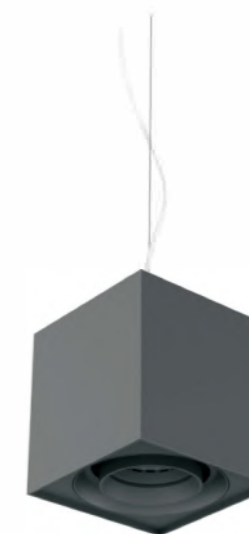

LP-S0316-30

Lamp: PHILIPS
Power: 30W
Lumens: 78~90LM/W
Voltage: 180~240V
CCT: 3000K
CRI: 90
Beam Angle: 15° / 24° / 36°
Tilting Angle: 35°



LP-S0317-30

Lamp: PHILIPS
Power: 30W
Lumens: 78~90LM/W
Voltage: 180~240V
CCT: 3000K
CRI: 90
Beam Angle: 15° / 24° / 36°
Tilting Angle: 35°

UNIT:mm

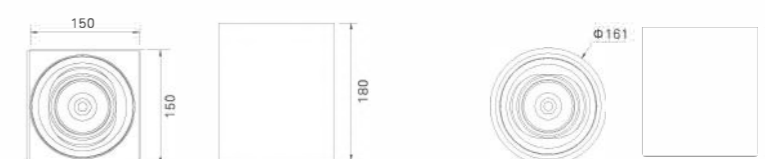

Beam angle

PHILIPS 30W

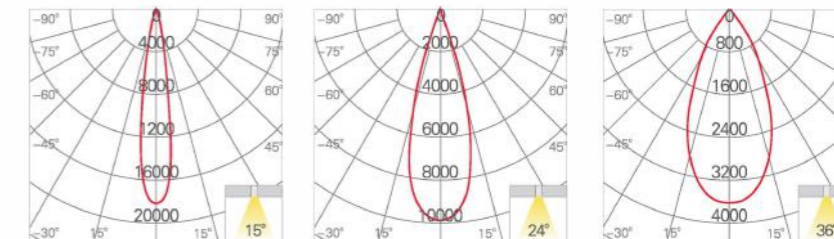

Colors



Black



White





Recessed light Wall Washer

Flow series Wall Washer



Heat Sink



Lens



Tilttable Part



Secondary Optics

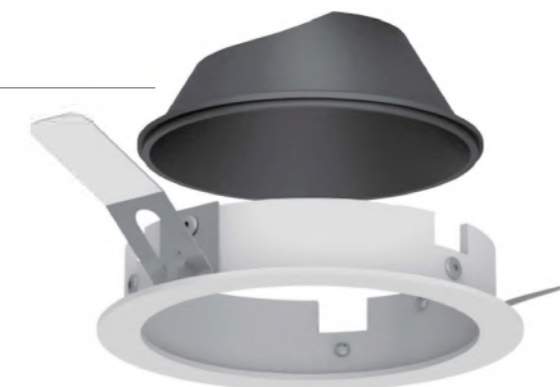

LP-R1043A-10
COB 10W
CUT-OUT : Φ89mm



LP-R1043B-10
COB 10W
CUT-OUT : Φ89mm



LP-R1043-10
COB 10W
CUT-OUT : Φ89mm



LP-R1043-20
COB 20W
CUT-OUT : Φ107mm



LP-R1043-30
COB 30W
CUT-OUT : Φ171mm



LP-R1043A-10

Lamp: PHILIPS
Power: 10W
Lumens: 78-90LM/W
Voltage: 180-240V
CCT: 3000K
CRI: 90
Beam Angle: 15° / 24° / 36°
Tilting Angle: 35°
CUT-OUT: Φ89mm

LP-R1043B-10

Lamp: PHILIPS
Power: 10W
Lumens: 78-90LM/W
Voltage: 180-240V
CCT: 3000K
CRI: 90
Beam Angle: 15° / 24° / 36°
Tilting Angle: 35°
CUT-OUT: Φ89mm

LP-R1043-10

Lamp: PHILIPS
Power: 10W
Lumens: 78-90LM/W
Voltage: 180-240V
CCT: 3000K
CRI: 90
Beam Angle: 15° / 24° / 36°
Tilting Angle: 35°
CUT-OUT: Φ89mm

UNIT:mm



Beam angle
PHILIPS 10W

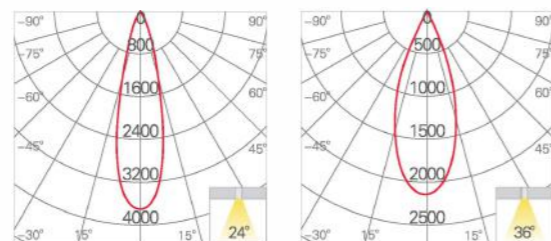

Colors



White



LP-R1043-20

Lamp: PHILIPS
Power: 20W
Lumens: 78-90LM/W
Voltage: 180-240V
CCT: 3000K
CRI: 90
Beam Angle: 15° / 24° / 36°
Tilting Angle: 35°
CUT-OUT: Φ107mm

LP-R1043-30

Lamp: PHILIPS
Power: 30W
Lumens: 78-90LM/W
Voltage: 180-240V
CCT: 3000K
CRI: 90
Beam Angle: 15° / 24° / 36°
Tilting Angle: 35°
CUT-OUT: Φ171mm

UNIT:mm

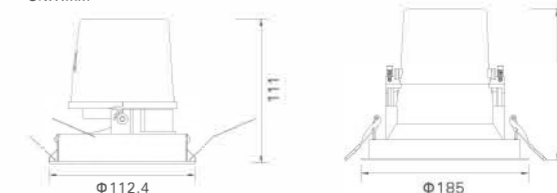

Beam angle
PHILIPS 20W

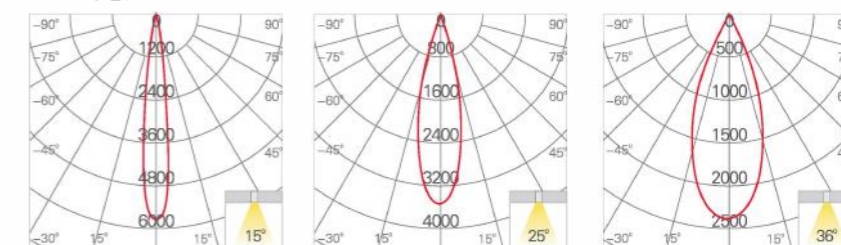

PHILIPS 30W

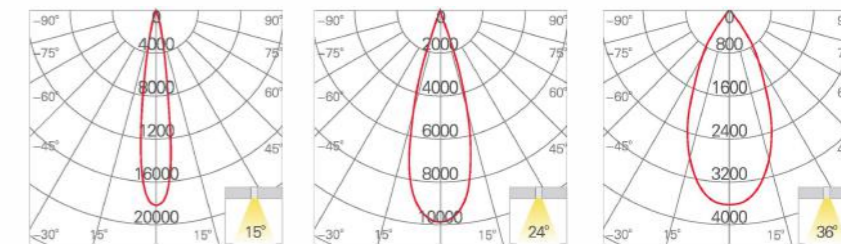

Colors



White





LP-R1044-10

Lamp: PHILIPS
Power: 10W
Lumens: 78-90LM/W
Voltage: 180-240V
CCT: 3000K
CRI: 90
Beam Angle: 15° / 24° / 36°
Tilting Angle: 35°
CUT-OUT: Φ73mm

LP-R1044-20

Lamp: PHILIPS
Power: 20W
Lumens: 78-90LM/W
Voltage: 180-240V
CCT: 3000K
CRI: 90
Beam Angle: 15° / 24° / 36°
Tilting Angle: 35°
CUT-OUT: Φ109mm

LP-R1044-30

Lamp: PHILIPS
Power: 30W
Lumens: 78-90LM/W
Voltage: 180-240V
CCT: 3000K
CRI: 90
Beam Angle: 15° / 24° / 36°
Tilting Angle: 35°
CUT-OUT: Φ152mm

UNIT:mm

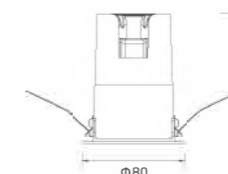

Beam angle

PHILIPS 20W

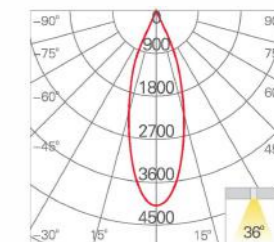
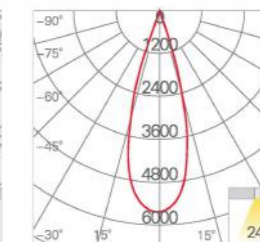
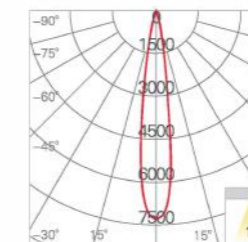

PHILIPS 30W

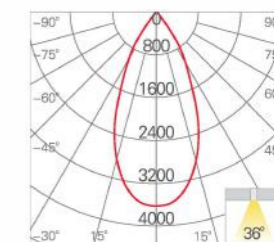
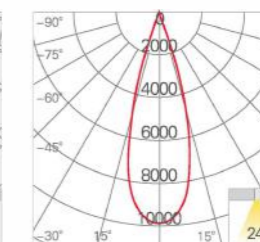
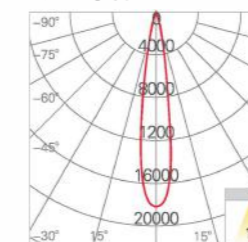

Colors



White



LP-R1044-10
COB 10W
CUT-OUT : Φ73mm



LP-R1044-20
COB 20W
CUT-OUT : Φ109mm



LP-R1044-30
COB 30W
CUT-OUT : Φ152mm



Flow series Track Light



Heat Sink

COB

Lens

Honey Comb

Cross-louvre



Track Light **Flow** - Track Light



LP-I0730-10
COB 10W
Φ60mm



LP-I0730-20
COB 20W
Φ80mm



LP-I0730-30
COB 30W
Φ100mm



LP-I0730-10

Lamp: PHILIPS
 Power: 10W
 Lumens: 78~90LM/W
 Voltage: 180~240V
 CCT: 3000K
 CRI: 90
 Beam Angle: 15° / 24° / 36°
 Tilting Angle: 35°

LP-I0730-20

Lamp: PHILIPS
 Power: 20W
 Lumens: 78~90LM/W
 Voltage: 180~240V
 CCT: 3000K
 CRI: 90
 Beam Angle: 15° / 24° / 36°
 Tilting Angle: 35°

LP-I0730-30

Lamp: PHILIPS
 Power: 30W
 Lumens: 78~90LM/W
 Voltage: 180~240V
 CCT: 3000K
 CRI: 90
 Beam Angle: 15° / 24° / 36°
 Tilting Angle: 35°

UNIT:mm

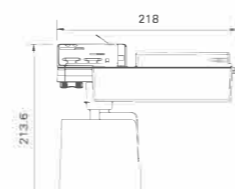
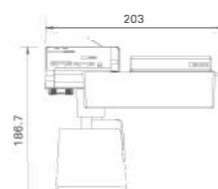
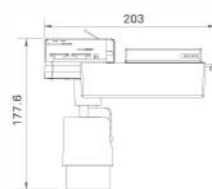

Beam angle PHILIPS 20W

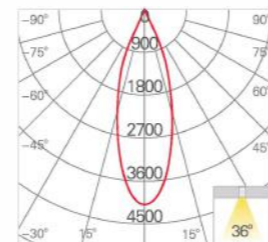
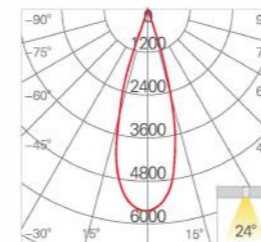
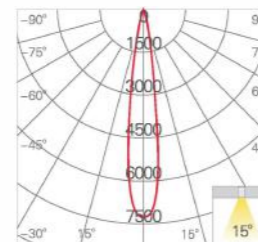

PHILIPS 30W

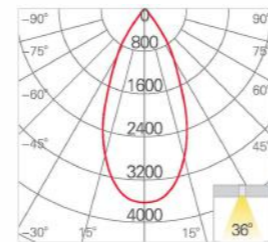
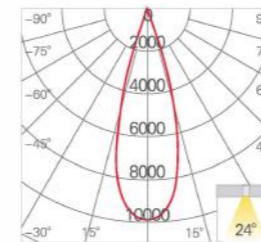
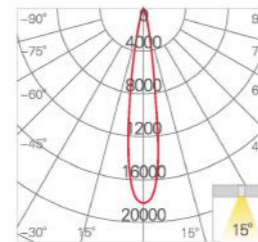

Colors



Black

White



Alex

Mix & Match Series
The one makes things easy



Power
40W

Lumen
4000lm

CRI
90

CCT
3000K

Beam Angle
12°/24°/38°

Product Feature:

- Built-in light engine and driver.
- Mix & Match Modular.
- ONE engine MULTI fixtures
- led engine 20W / 30W / 40W.

 LP-A0949 220~240V ~50/60Hz 1000mA Power: 40W Material: Aluminium Ø: 12,45 cm H: 29,95 cm	 LP-S0240 220~240V ~50/60Hz 1000mA Power: 40W Material: Aluminium Ø: 12,45 cm H: 20,8 cm	 LP-S0241 220~240V ~50/60Hz 1000mA Power: 40W Material: Aluminium Ø: 31,35 cm H: 41,1 cm	 LP-I0735 220~240V ~50/60Hz Power: 15W Material: Aluminium Ø: 12,45 cm H: 26,75 cm
 LP-I0734 AC 220~240V ~50/60Hz Power: 40W Material: Aluminium Ø: 12,45 cm H: 26,75 cm	 LP-S0242 AC 220~240V ~50/60Hz Power: 40W Material: Aluminium Ø: 12,45 cm H: 17,3 cm	 LP-S0243 AC 220~240V ~50/60Hz Power: 40W Material: Aluminium Ø: 31,45 cm H: 37,6 cm	 LP-I0736 220~240V ~50/60Hz Power: 6W Material: Aluminium Ø: 7,0 cm H: 17,6 cm



Fantasy

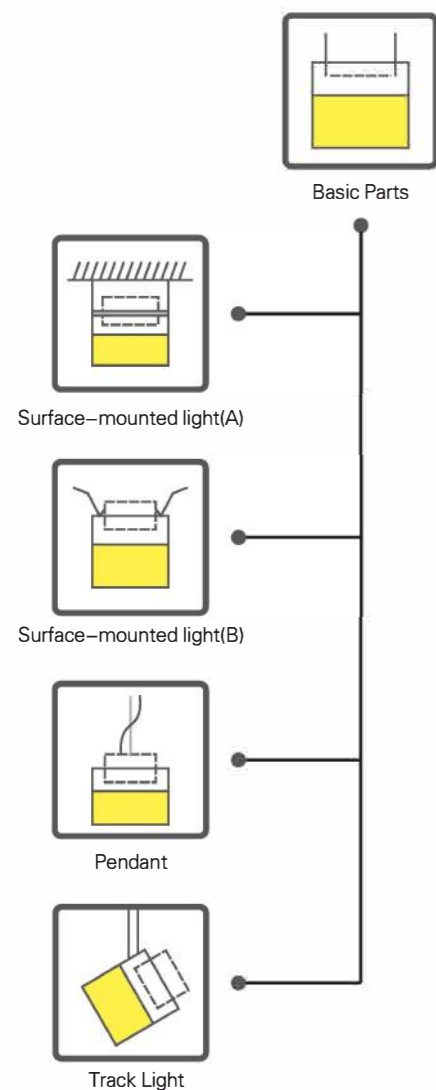
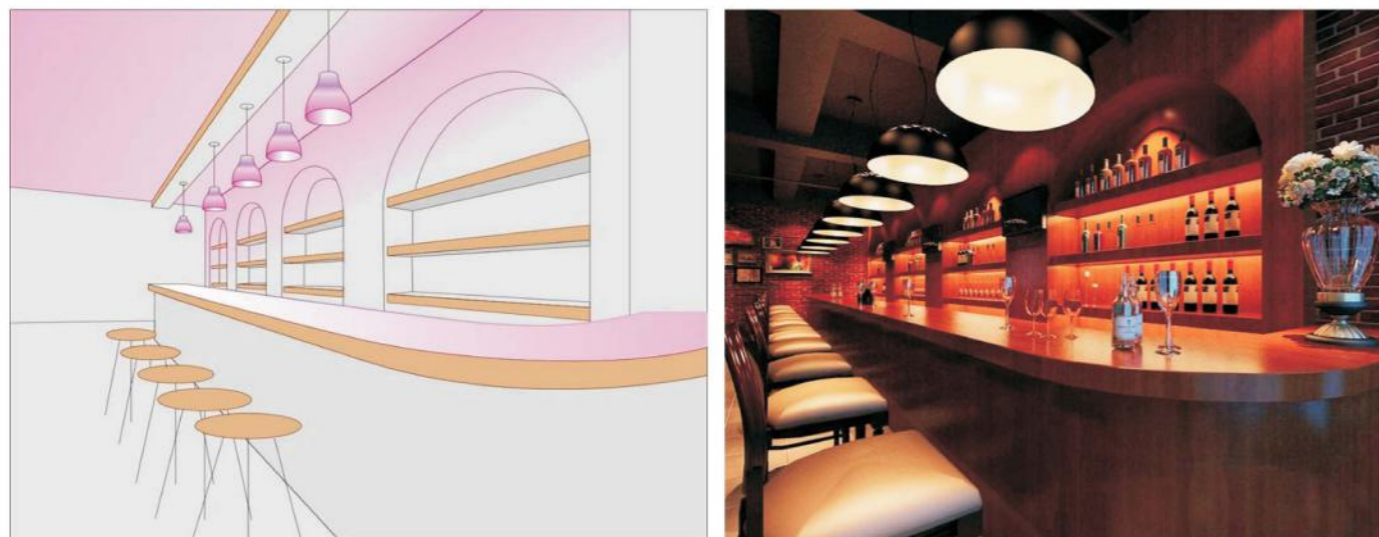



Recessed light

Fantasy



LP-R0732-40

Lamp: TX-1936SW17A-2757V33-01H90+RGB
 Power: 30W+RGB10W
 Lumens: 78-90LMW
 Voltage: 180-240V
 CCT: 2765K
 CRI: 90
 Beam Angle: 15° / 24° / 45°
 CUT-OUT: Φ160mm

UNIT:mm

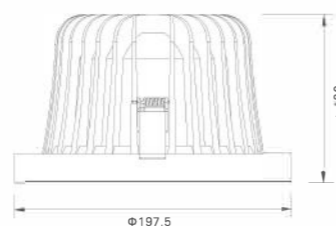

Beam angle

TX-1936SW17A-2757V33-01H90 30W

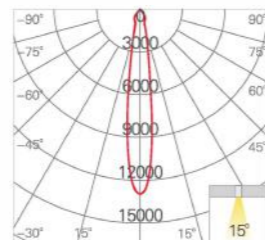

Colors



White

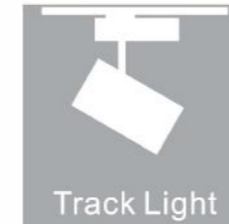

Track Light

Fantasy Track Light



LP-1006-40

Lamp: TX1936SW+5050
 Power: 30W + RGB7.5W
 Lumens: 2750-3800LM
 Voltage: 180-240V
 CCT: 2700-6500K
 CRI: 80
 Beam Angle: 8° / 21° / 38°
 Tilting Angle: 90°

UNIT:mm

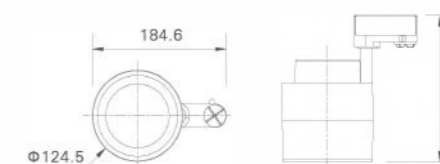

Beam angle

TX-1936SW17A-2757V33-01H90 30W

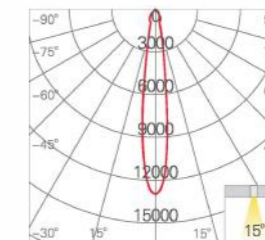

Colors



White



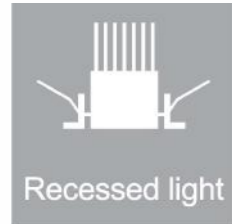

Recessed light

Recessed Light

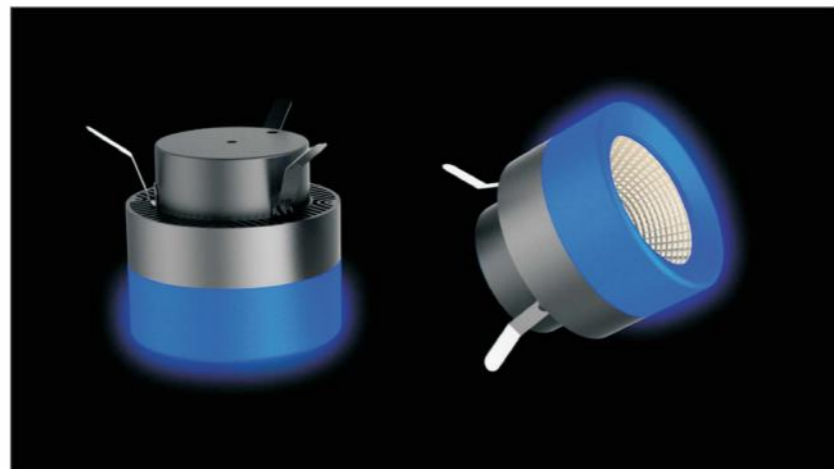

LP-R1006-40

Lamp: TX1936SW+5050
 Power: 30W + RGB 7.5W
 Lumens: 2750-3800LM
 Voltage: 180-240V
 CCT: 2700~6500K
 CRI: 80
 Beam Angle: 8° / 21° / 38°
 CUT-OUT: Φ115mm

UNIT:mm

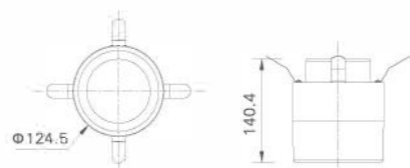

Beam angle

TX-1936SW17A-2757V33-01H90 30W

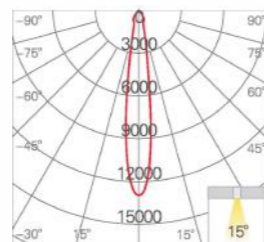

Colors



White

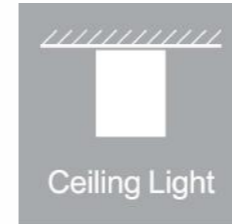

Ceiling Light

Fantasy
Surface-mounted Light

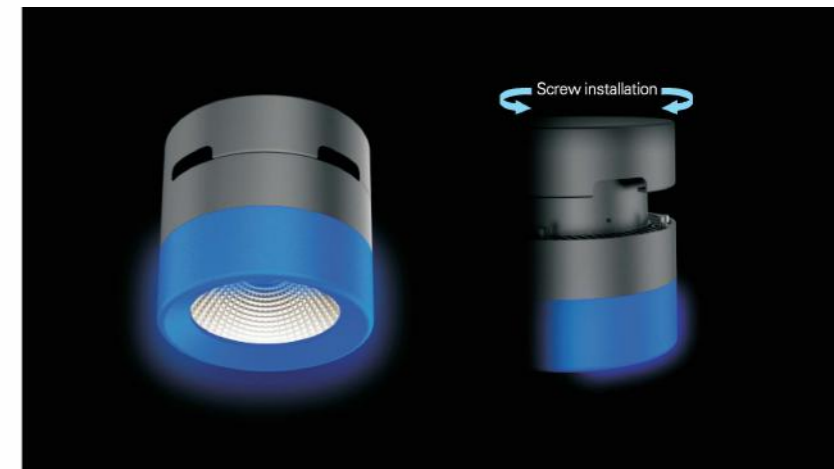

LP-S1006-40

Lamp: TX1936SW+5050
 Power: 30W + RGB 7.5W
 Lumens: 2750-3800LM
 Voltage: 180-240V
 CCT: 2700~6500K
 CRI: 80
 Beam Angle: 8° / 21° / 38°

UNIT:mm

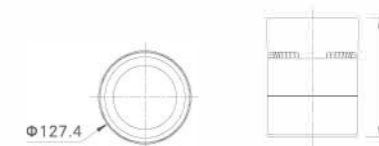

Beam angle

TX-1936SW17A-2757V33-01H90 30W

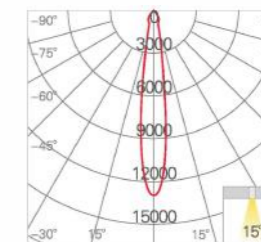

Colors



White





Pendant

Fantasy Pendant



LP-D1006-40

Lamp: TX1936SW+5050
 Power: 30W + RGB 7.5W
 Lumens: 2750-3800LM
 Voltage: 180-240V
 CCT: 2700 - 6500K
 CRI: 80
 Beam Angle: 8° / 21° / 38°

UNIT:mm

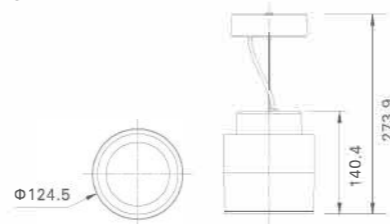

Beam angle

TX-1936SW17A-2757V33-01H90 30W

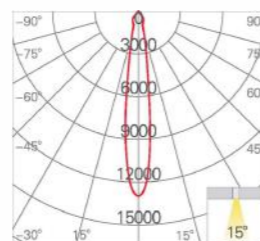

Colors



White



Magic Column - Track Light



Cloud Lighting Driver

Tunable White COB

RGB

Frosted Housing





Track Light

Magic Column - Track Light



LP-I0731-40

Lamp: TX-2548SW21A-2757V33-01H90+RGB
 Power: 40W + RGB7.5W
 Lumens: 78-90LM/W
 Voltage: 180-240V
 CCT: 2765K
 CRI: 90
 Beam Angle: 15° / 24° / 40°
 Tilting Angle: 90°

UNIT:mm

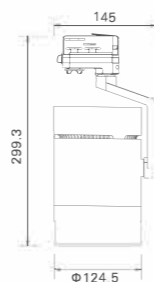

Beam angle

TX-1936SW17A-2757V33-01H90 30W

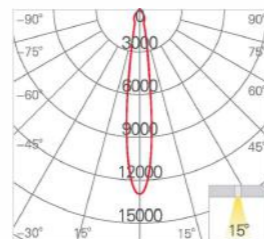

Colors



Black

White



Pendant

Magic Column Pendant



LP-D0731-40

Lamp: TX-2548SW21A-2757V33-01H90+RGB
 Power: 40W + RGB7.5W
 Lumens: 78-90LM/W
 Voltage: 180-240V
 CCT: 2765K
 CRI: 90
 Beam Angle: 15° / 24° / 40°

UNIT:mm

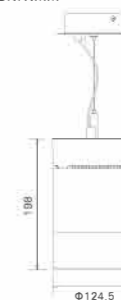

Beam angle

TX-1936SW17A-2757V33-01H90 30W

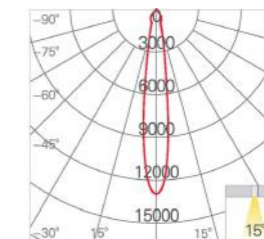

Colors



Black

White

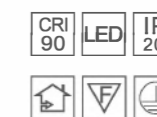

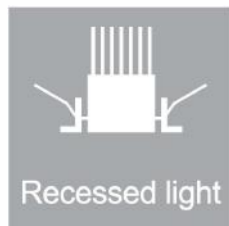

Recessed light

Magic Column

- Recessed Light



LP-R0731-40

Lamp: TX-2548SW21A-2757V33-01H90+RGB
 Power: 40W + RGB7.5W
 Lumens: 78~90LM/W
 Voltage: 180-240V
 CCT: 2765K
 CRI: 90
 Beam Angle: 15° / 24° / 40°
 CUT-OUT: Φ133mm

UNIT:mm

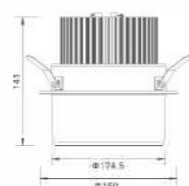

Beam angle

TX-1936SW17A-2757V33-01H90 30W

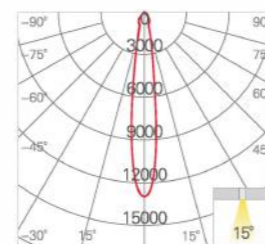

Colors



Black



White

