

# CONTENTS

SPECIALIZED MANUFACTURER  
LED LIGHTING PRODUCTS

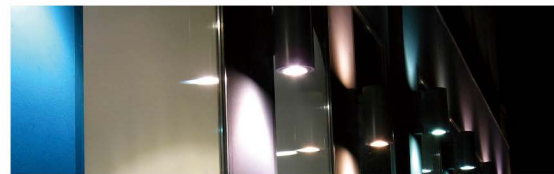

07-10 FOUNTAIN LIGHT



123-143 WALL LIGHT



13-30 SPOT LIGHT



147-151 SPIKE LIGHT



33-99 GROUND LIGHT



155-159 QUICK INSTALL LIGHT

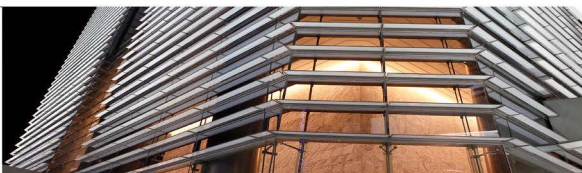
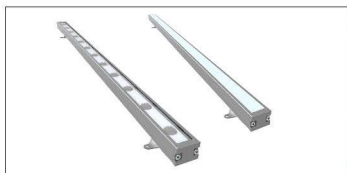

103-113 LINE LIGHTING



117-120 LED COMPONENTS



163-172 ACCESSORIES



# FOUNTAIN LIGHT

SPECIALIZED MANUFACTURER  
LED LIGHTING PRODUCTS

## lumeplus

---





## FL410 FOUNTAIN LIGHT



### DESCRIPTION

<b>LED Light source</b>	High Power LED
<b>Light Color</b>	RGB,CW,WW,NW,Red,Green,Blue,Amber
<b>Material</b>	SUS316 + 6mm Toughened glass
<b>Optics</b>	15° / S20° / 30° / 45° / F60°
<b>Power</b>	9W / 9*2W / 9*3W
<b>Power supply</b>	12VDC or 24VDC
<b>Dimension</b>	D173XH41
<b>Weight</b>	1420g
<b>IP Rating</b>	IP68
<b>Approvals</b>	CE,RoHS,IP
<b>Ambient temperature</b>	-20°C ~ +45°C
<b>Average life</b>	50,000Hrs
<b>Accessories(Optional)</b>	Constant voltage DMX Controller
<b>Applications</b>	surface mounted; Fountains, artificial lakes, natural lakes, swimming halls, aquariums and other underwater lighting or decoration may apply



#### LED Colours



Assembling instruction  
Nozzle dimension D50mm MAX.

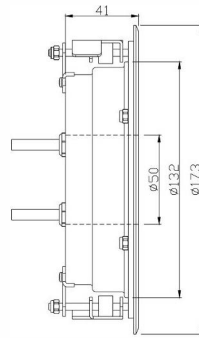
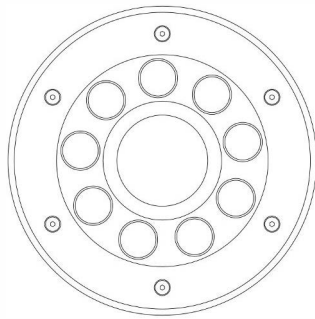
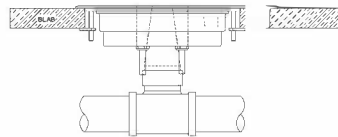

Model No.	LED Brand	Color	Beam	Input	Wiring	Cable	Power	Luminous Flux	Dimension	Aperture	DrillSize
LP410D	CREE	CW,WW,NW,Red,Green,Blue,Amber	15/S20/30/45/F60	12VDC or 24VDC	Parallel	3M 2X0.75mm <sup>2</sup> Cable or 1.1M Plug	9W	800LM	D173XH41	D50	D160
LP410DMX	CREE	CW,WW,NW,Red,Green,Blue,Amber	15/S20/30/45/F60	12VDC or 24VDC DMX Controller	Parallel	2x1.1M 5X0.5mm <sup>2</sup> Cable or 1.1M Plug	10W	800LM	D173XH41	D50	D160
LP410DMX-RGB	CREE	3R+3G+3B	15/S20/30/45/F60	12VDC or 24VDC DMX Controller	Parallel	2x1.1M 5X0.5mm <sup>2</sup> Cable or 1.1M Plug	10W	N/A	D173XH41	D50	D160
LP410DMX-RGB	Edison	RGB(Fullcolor)	15/S20/30/15/F60	12VDC or 24VDC DMX Controller	Parallel	2x1.1M 5X0.5mm <sup>2</sup> Cable or 1.1M Plug	10W	N/A	D173XH41	D50	D160
LP410DMX-RGBW	Edison	RGBW(Fullcolor)	15/S20/30/45/F60	12VDC or 24VDC DMX Controller	Parallel	2x1.1M 5X0.5mm <sup>2</sup> Cable or 1.1M Plug	12W	N/A	D173XH41	D50	D160

DMX decoder is built

\*IES Data support.

\*Power could be customized

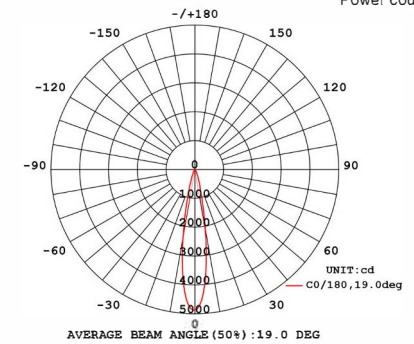
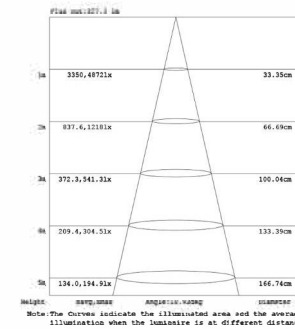

## FL411 FOUNTAIN LIGHT



### LED Colours

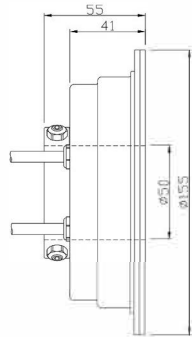
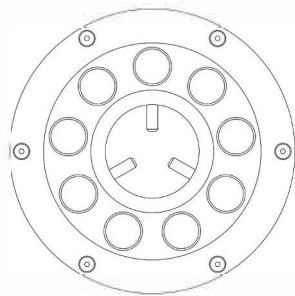
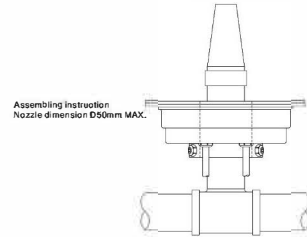

### DESCRIPTION

<b>LED Light source</b>	High Power LED
<b>Light Color</b>	RGB,CW,WW,NW,Red,Green,Blue,Amber
<b>Material</b>	SUS316
<b>Optics</b>	15° / S20° / 30° / 45° / F60*
<b>Power</b>	9W / 9*2W / 9*3W
<b>Power supply</b>	12VDC or 24VDC
<b>Dimension</b>	D155XH55
<b>Weight</b>	1460g
<b>IP Rating</b>	IP68
<b>Approvals</b>	CE,RoHS,IP
<b>Ambient temperature</b>	-20°C ~ +45°C
<b>Average life</b>	50,000Hrs
<b>Accessories(Optional)</b>	Constant voltage DMX Controller
<b>Applications</b>	Fountains, artificial lakes, natural lakes, swimming halls, aquariums and other underwater lighting or decoration may apply



Model No.	LED Brand	Color	Beam	Input	Wiring	Cable	Power	Luminous Flux	Dimension	Aperture	Drill Size
FL411D	CREE	CW,WW,NW,Red,Green,Blue,Amber	15/S20/30/45/F60	12VDC or 24VDC	Parallel	3M 2X0.75mm <sup>2</sup> Cable or 1.1M Plug	9W	800LM	D155XH55	D50	N/A
FL411DMX	CREE	CW,WW,NW,Red,Green,Blue,Amber	15/S20/30/45/F60	12VDC or 24VDC DMX Controller	Parallel	2x1.1M 5X0.5mm <sup>2</sup> Cable or 1.1M Plug	10W	800LM	D155XH55	D50	N/A
FL411DMX-RGB	CREE	3R+3G+3B	15/S20/30/45/F60	12VDC or 24VDC DMX Controller	Parallel	2x1.1M 5X0.5mm <sup>2</sup> Cable or 1.1M Plug	10W	N/A	D155XH55	D50	N/A
FL411DMX-RGB	Edison	RGB(Fullcolor)	15/S20/30/45/F60	12VDC or 24VDC DMX Controller	Parallel	2x1.1M 5X0.5mm <sup>2</sup> Cable or 1.1M Plug	10W	N/A	D155XH55	D50	N/A
FL411DMX-RGBW	Edison	RGBW(Fullcolor)	15/S20/30/45/F60	12VDC or 24VDC DMX Controller	Parallel	2x1.1M 5X0.5mm <sup>2</sup> Cable or 1.1M Plug	12W	N/A	D155XH55	D50	N/A

DMX decoder is built

\*IES Data support.

\*Power could be customized

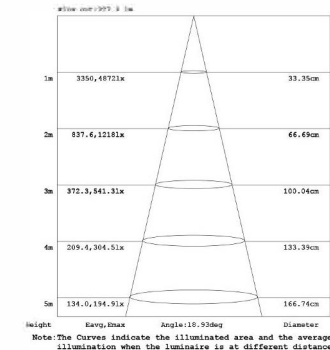
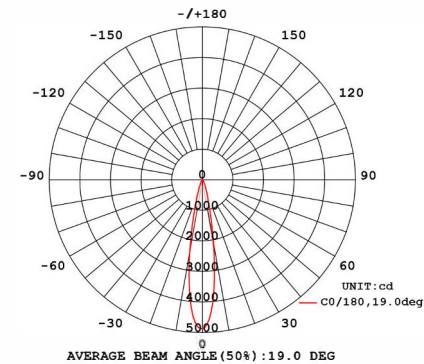





# SPOT LIGHT

SPECIALIZED MANUFACTURER  
LED LIGHTING PRODUCTS

## LP624 SPOT LIGHT



### LED Colours

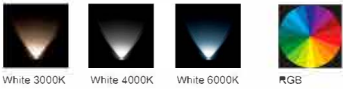

### LP624

Bar stock aluminum surface mounted projector complete with integral CREE LED(24pcs) package.Tempered glass, fixture rated to IP67 and configured to 10/20/40/60 degree beam options. No mechanical joints to light source ensures robust protection against water ingress. Product runs cool meeting all touch temperature requirements. Suitable for the illumination of small/medium trees, building exteriors, columns.

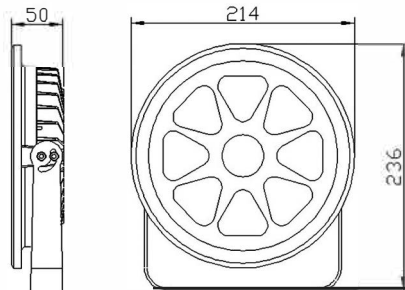

### DESCRIPTION

<b>LED Light source</b>	High Power LED
<b>Light Color</b>	RGB,CW,WW,NW,Red,Green,Blue,Amber
<b>Material</b>	Aluminum+SUS316(Bracket)
<b>Optics</b>	10° / S20° / 40° / F60°
<b>Power</b>	24x1W
<b>Power supply</b>	N/A
<b>Dimension</b>	214XH236XT50
<b>Weight</b>	1.7KG
<b>IP Rating</b>	IP67
<b>Approvals</b>	CE,RoHS,IP
<b>Ambient temperature</b>	-20°C ~ +45°C
<b>Average life</b>	50,000Hrs
<b>Accessories(Optional)</b>	N/A
<b>Applications</b>	Indoor/Outdoor/Landscape



Model No.	LED Brand	Color	Beam	PowerMode	Input	Wiring	Cable	Power	Luminous Flux	Dimension	DrillSize
LP624	CREE	CW,WW, NW,Red, Green,Blue,Amber	10/S20/40/F60	Constant current	350mA	Series	3M 2X0.75mm <sup>2</sup> Cable	24W	2200LM	214XH236XT50	N/A
LP624D	CREE	CW,WW, NW,Red, Green,Blue,Amber	10/S20/40/F60	Constant voltage	24VDC	Parallel	3M 2X0.75mm <sup>2</sup> Cable	26W	2200LM	214XH236XT50	N/A
LP624RGB	CREE	8R+8G+8B	10/S20/40/F60	Constant current	350mA	Series	2x3M 4X0.5mm <sup>2</sup> Cable	24W	N/A	214XH236XT50	N/A
LP624DMX-100	CREE	8R+8G+8B	10/S20/40/F60	Constant voltage	24VDC DMX Controller	Parallel	1.1M 4X0.5mm <sup>2</sup> Cable	26W	N/A	214XH236XT50	N/A

DMX decoder in built

\*IES Data support.

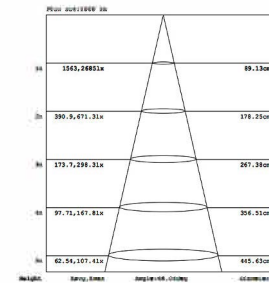
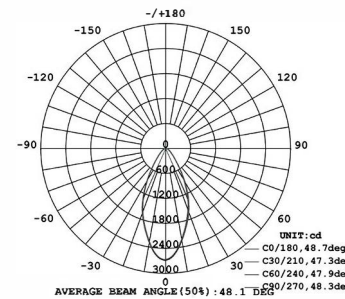



## LP824 SPOT LIGHT



### LED Colours

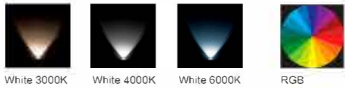

### LP824

Bar stock aluminum surface mounted projector complete with integral CREE LED(24pcs) package. Tempered glass, fixture rated to IP68 and configured to 10/20/40/60 degree beam options. No mechanical joints to light source ensures robust protection against water ingress. Product runs cool meeting all touch temperature requirements. Suitable for the illumination of small/medium trees, building exteriors, columns.

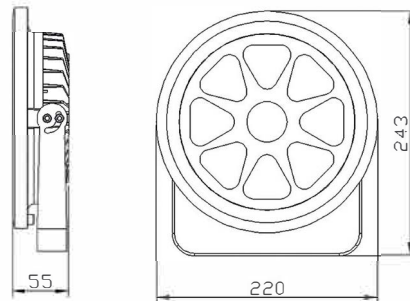

### DESCRIPTION

<b>LED Light source</b>	High Power LED
<b>Light Color</b>	RGB,CW,WW,NW,Red,Green,Blue,Amber
<b>Material</b>	Aluminum+SUS316(Bracket)
<b>Optics</b>	10° / S20° / 40° / F60*
<b>Power</b>	24x1W
<b>Power supply</b>	N/A
<b>Dimension</b>	220XH243XT50
<b>Weight</b>	2.8KG
<b>IP Rating</b>	IP67
<b>Approvals</b>	CE,RoHS,IP
<b>Ambient temperature</b>	-20°C ~ +45°C
<b>Average life</b>	50,000Hrs
<b>Accessories(Optional)</b>	N/A
<b>Applications</b>	Indoor/Outdoor/Landscape

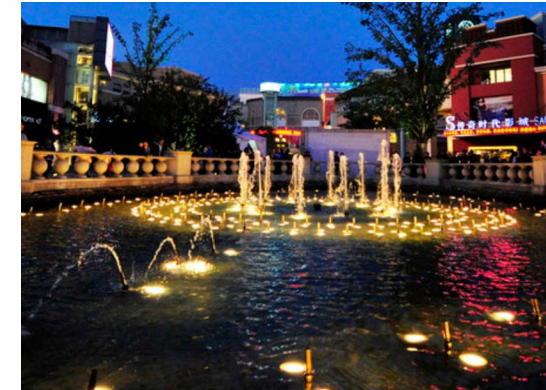

Model No.	LED Brand	Color	Beam	PowerMode	Input	Wiring	Cable	Power	Luminous Flux	Dimension	DrillSize
LP824	CREE	CW,WW, NW,Red Green,Blue,Amber	10/S20/40/F60	Constant current	350mA	Series	3M 2X0.75mm <sup>2</sup> Cable	24W	2200LM	220XH243XT50	N/A
LP824D	CREE	CW,WW, NW,Red Green,Blue,Amber	10/S20/40/F60	Constant voltage	24VDC	Parallel	3M 2X0.75mm <sup>2</sup> Cable	26W	2200LM	220XH243XT50	N/A
LP824RGB	CREE	8R+8G+8B	10/S20/40/F60	Constant current	350mA	Series	2x3M 4X0.5mm <sup>2</sup> Cable	24W	N/A	220XH243XT50	N/A

DMX decoder in built

\*IES Data support.

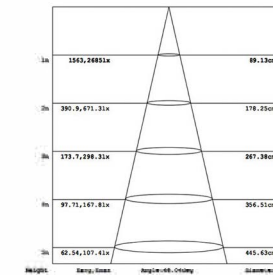
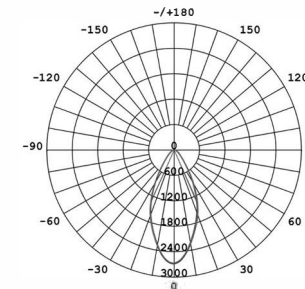

## LP618 SPOT LIGHT



### LED Colours



White 3000K   White 4000K   White 6000K   RGB

### LP618

Bar stock aluminum surface mounted projector complete with integral CREE LED (18pcs) package. Tempered glass, fixture rated to IP67 and configured to 10/20/40/60 degree beam options. No mechanical joints to light source ensures robust protection against water ingress. Product runs cool meeting all touch temperature requirements. Suitable for the illumination of small/medium trees, building exteriors, columns.

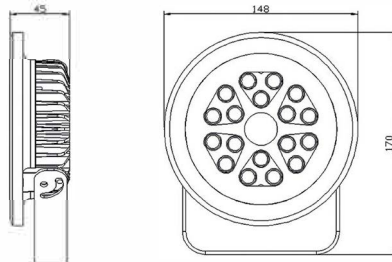

### DESCRIPTION

<b>LED Light source</b>	High Power LED
<b>Light Color</b>	RGB, CW, WW, NW, Red, Green, Blue, Amber
<b>Material</b>	Aluminum+SUS316 (Bracket)
<b>Optics</b>	10° / S20° / 40° / F60°
<b>Power</b>	18x1W
<b>Power supply</b>	N/A
<b>Dimension</b>	148XH170XT45
<b>Weight</b>	1.1KG
<b>IP Rating</b>	IP67
<b>Approvals</b>	CE, RoHS, IP
<b>Ambient temperature</b>	-20°C ~ +45°C
<b>Average life</b>	50,000Hrs
<b>Accessories(Optional)</b>	N/A
<b>Applications</b>	Indoor / Outdoor / Landscape



Model No.	LED Brand	Color	Beam	Power Mode	Input	Wiring	Cable	Power	Luminous Flux	Dimension	Drill Size
LP618	CREE	CW, WW, NW, Red, Green, Blue, Amber	10/S20/40/F60	Constant current	350mA	Series	3M 2X0.75mm <sup>2</sup> Cable	18W	1700LM	148XH170XT45	N/A
LP618D	CREE	CW, WW, NW, Red, Green, Blue, Amber	10/S20/40/F60	Constant voltage	24VDC	Parallel	3M 2X0.75mm <sup>2</sup> Cable	20W	1700LM	148XH170XT45	N/A
LP618RGB	CREE	6R+6G+6B	10/S20/40/F60	Constant current	350mA	Series	2x3M 4X0.5mm <sup>2</sup> Cable	18W	N/A	148XH170XT45	N/A
LP618DMX-RGB	CREE	6R+6G+6B	10/S20/40/F60	Constant voltage	24VDC DMX Controller	Parallel	1.1M 4X0.5mm <sup>2</sup> Cable	20W	N/A	148XH170XT45	N/A
LP618DMX-RGB	Edison	RGB(Fullcolor)	10/S20/40/F60	Constant voltage	24VDC DMX Controller	Parallel	1.1M 4X0.5mm <sup>2</sup> Cable	20W	N/A	148XH170XT45	N/A
LP618DMX-RGBW	Edison	RGBW(Fullcolor)	10/S20/40/F60	Constant voltage	24VDC DMX Controller	Parallel	1.1M 4X0.5mm <sup>2</sup> Cable	20W	N/A	148XH170XT45	N/A

DMX decoder in built

\*IES Data support.

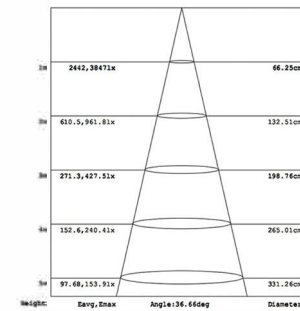
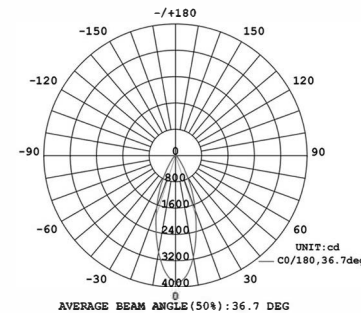



# LP612 SPOT LIGHT



### LED Colours

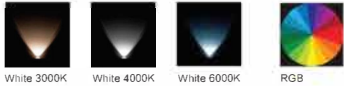

### LP612

Bar stock aluminum surface mounted projector complete with integral CREE LED (12pcs) package. Tempered glass, fixture rated to IP67 and configured to 10/20/40/60 degree beam options. No mechanical joints to light source ensures robust protection against water ingress. Product runs cool meeting all touch temperature requirements. Suitable for the illumination of small/medium trees, building exteriors, columns.

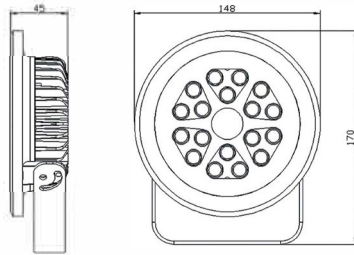

### DESCRIPTION

<b>LED Light source</b>	High Power LED
<b>Light Color</b>	RGB,CW,WW,NW,Red,Green,Blue,Amber
<b>Material</b>	Aluminum+SUS316(Bracket)
<b>Optics</b>	10° / S20° / 40° / F60°
<b>Power</b>	12x1W
<b>Power supply</b>	N/A
<b>Dimension</b>	148XH170XT45
<b>Weight</b>	1.1KG
<b>IP Rating</b>	IP67
<b>Approvals</b>	CE,RoHS,IP
<b>Ambient temperature</b>	-20°C ~ +45°C
<b>Average life</b>	50,000Hrs
<b>Accessories(Optional)</b>	N/A
<b>Applications</b>	Indoor/Outdoor/Landscape

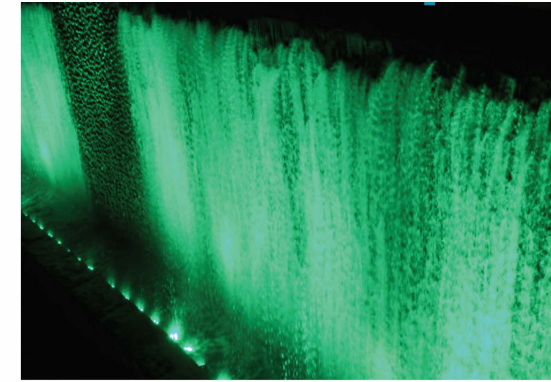

Model No.	LED Brand	Color	Beam	PowerMode	Input	Wiring	Cable	Power	Luminous Flux	Dimension	DrillSize
LP612	CREE	CW,WW, NW,Red Green,Blue,Amber	10/S20/40/F60	Constant current	350mA	Series	3M 2X0.75mm <sup>2</sup> Cable	12W	1300LM	148XH170XT45	N/A
LP612D	CREE	CW,WW, NW,Red Green,Blue,Amber	10/S20/40/F60	Constant voltage	24VDC	Parallel	3M 2X0.75mm <sup>2</sup> Cable	13W	1300LM	148XH170XT45	N/A
LP612RGB	CREE	4R+4G+4B	10/S20/40/F60	Constant current	350mA	Series	2x3M 4X0.5mm <sup>2</sup> Cable	12W	N/A	148XH170XT45	N/A
LP612DMX-RGB	CREE	4R+4G+4B	10/S20/40/F60	Constant voltage	24VDC DMX Controller	Parallel	1.1M 4X0.5mm <sup>2</sup> Cable	13W	N/A	148XH170XT45	N/A
LP612DMX-RGB	Edison	RGB(Fullcolor)	10/S20/40/F60	Constant voltage	24VDC DMX Controller	Parallel	1.1M 4X0.5mm <sup>2</sup> Cable	13W	N/A	148XH170XT45	N/A
LP612DMX-RGBW	Edison	RGBW(Fullcolor)	10/S20/40/F60	Constant voltage	24VDC DMX Controller	Parallel	1.1M 4X0.5mm <sup>2</sup> Cable	13W	N/A	148XH170XT45	N/A

DMX decoder in built

\*IES Data support.

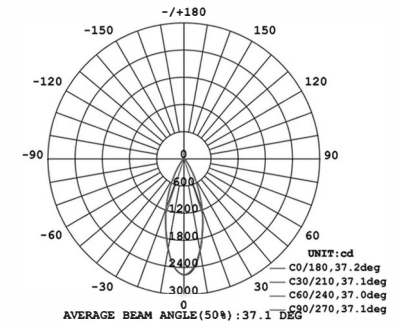
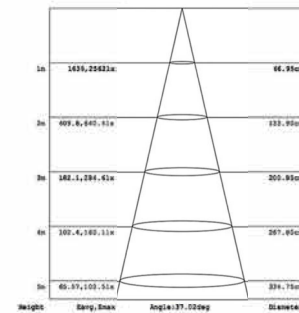

## LP608 SPOT LIGHT



### LED Colours



White 3000K White 4000K White 6000K RGB

### LP608

Bar stock aluminum surface mounted projector complete with integral CREE LED (6pcs) package. Tempered glass, fixture rated to IP67 and configured to 10/40 degree beam options. No mechanical joints to light source ensures robust protection against water ingress. Product runs cool meeting all touch temperature requirements. Suitable for the illumination of small/medium trees, building exteriors, columns.

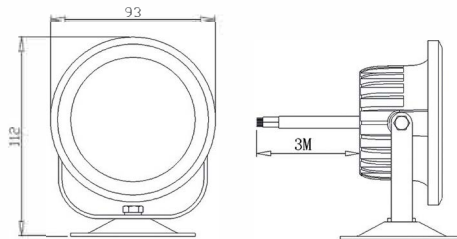

### DESCRIPTION

<b>LED Light source</b>	High Power LED
<b>Light Color</b>	RGB,CW,WW,NW,Red,Green,Blue,Amber
<b>Material</b>	Aluminum
<b>Optics</b>	S10° / F40°
<b>Power</b>	6x1W (3x1W)
<b>Power supply</b>	N/A
<b>Dimension</b>	93X70X112
<b>Weight</b>	300g
<b>IP Rating</b>	IP67
<b>Approvals</b>	CE,RoHS,IP
<b>Ambient temperature</b>	-20°C ~ +45°C
<b>Average life</b>	50,000Hrs
<b>Accessories(Optional)</b>	N/A
<b>Applications</b>	Indoor/Outdoor/Landscape



Model No.	LED Brand	Color	Beam	PowerMode	Input	Wiring	Cable	Power	Luminous Flux	Dimension	DrillSize
LP608	CREE	CW,WW, NW,Red Green,Blue, Amber	S10/F40	Constant current	350mA	Series	3M 2X0.75mm <sup>2</sup> Cable	6W	500LM	93X70X112	N/A
LP608D	CREE	CW,WW, NW,Red Green,Blue, Amber	S10/F40	Constant voltage	24VDC	Parallel	3M 2X0.75mm <sup>2</sup> Cable	6.5W	500LM	93X70X112	N/A
LP608RG8	CREE	2R+2G+2B	S10/F40	Constant current	350mA	Series	2x3M 4X0.5mm <sup>2</sup> Cable	6W	N/A	93X70X112	N/A
LP608DMX-RGB	CREE	2R+2G+2B	S10/F40	Constant voltage	24VDC DMX Controller	Parallel	1.1M 4X0.5mm <sup>2</sup> Cable	6.5W	N/A	93X70X112	N/A
LP608DMX-RGB	Edison	RGB(Fullcolor)	S10/F40	Constant voltage	24VDC DMX Controller	Parallel	1.1M 4X0.5mm <sup>2</sup> Cable	6.5W	N/A	93X70X112	N/A
LP608DMX-RGBW	Edison	RGBW(Fullcolor)	S10/F40	Constant voltage	24VDC DMX Controller	Parallel	1.1M 4X0.5mm <sup>2</sup> Cable	6.5W	N/A	93X70X112	N/A

DMX decoder in built

\*IES Data support.

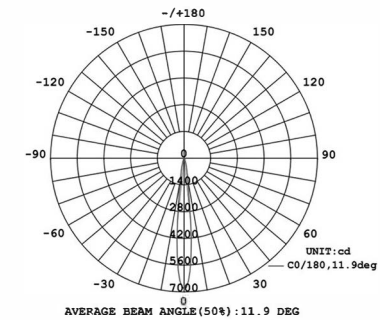
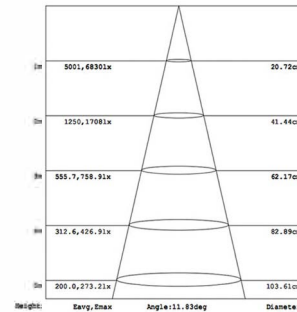



## LP023 SPOT LIGHT



LP023RGB

### LED Colours



White 3000K White 4000K White 6000K RGB

### LP023

Marine Grade 316 stainless steel miniature surface mounted fixture complete with integral CREE LED package. Tempered glass, fixture rated to IP68 allowing submersion in water thus negating common issues arising from lack of soil drainage. 20/45/60 degree beam options. No mechanical joints to light source ensures robust protection against water ingress. Product runs cool meeting all touch temperature requirements. Ideal as a surface mounted miniature marker light.

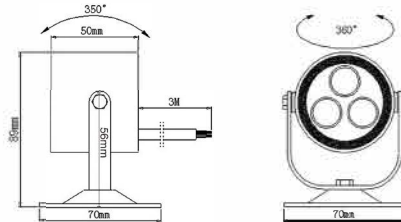

### DESCRIPTION

<b>LED Light source</b>	High Power LED
<b>Light Color</b>	RGB,CW,WW,NW,Red,Green,Blue,Amber
<b>Material</b>	SUS316
<b>Optics</b>	S20° / F60°
<b>Power</b>	3x1W
<b>Power supply</b>	N/A
<b>Dimension</b>	70x70x89
<b>Weight</b>	750g
<b>IP Rating</b>	IP68
<b>Approvals</b>	CE,RoHS,IP
<b>Ambient temperature</b>	-20°C ~ +45°C
<b>Average life</b>	50,000Hrs
<b>Accessories(Optional)</b>	N/A
<b>Applications</b>	Indoor / Outdoor / Landscape / Submersible



Model No.	LED Brand	Color	Beam	PowerMode	Input	Wiring	Cable	Power	Luminous Flux	Dimension	DrillSize
LP023	CREE	CW,WW, NW,Red Green,Blue,Amber	S20/F60	Constant current	350mA	Series	3M 2X0.75mm <sup>2</sup> Cable	3W	300LM	70x70x89	N/A
LP023D	CREE	CW,WW, NW,Red Green,Blue,Amber	S20/F60	Constant voltage	24VDC	Parallel	3M 2X0.75mm <sup>2</sup> Cable	3.5W	300LM	70x70x89	N/A
LP023RGB	Edison	RGB	10/20/45/60	Constant current	350mA	Series	2x3M 4X0.5mm <sup>2</sup> Cable	9W	N/A	70x70x89	N/A
LP023DMX-RGB	Edison	RGB	45	Constant voltage	24VDC DMX Controller	Parallel	1.1M 4X0.5mm <sup>2</sup> Cable	3.5W	N/A	70x70x89	N/A

DMX decoder in built

\*IES Data support.

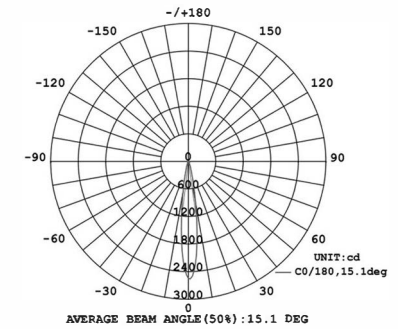
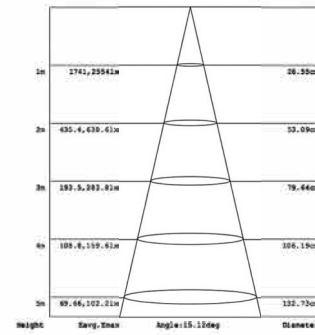

## LP023-2L SPOT LIGHT



### LED Colours



### LP023-2L

Marine grade 316 stainless steel surface mounted fixture complete with integral CREE LED package. Tempered glass, fixture rated to IP68 allowing submersion. 20/45/60 degree beam options, product functions with 350mA constant current driver. No mechanical joints to light source ensures robust protection against water ingress. Product runs cool meeting all touch temperature requirements. Elevated light source (500mm) allows for a down light effect to be created to paths and boundaries.

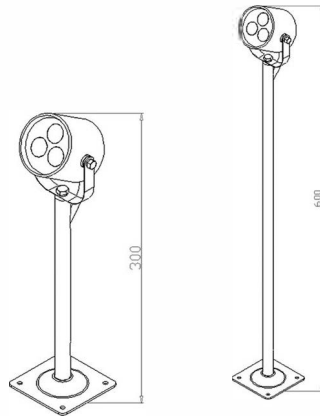

### DESCRIPTION

<b>LED Light source</b>	High Power LED
<b>Light Color</b>	RGB,CW,WW,NW,Red,Green,Blue,Amber
<b>Material</b>	SUS316
<b>Optics</b>	S20° / F60°
<b>Power</b>	3W
<b>Power supply</b>	N/A
<b>Dimension</b>	N/A
<b>Weight</b>	N/A
<b>IP Rating</b>	IP68
<b>Approvals</b>	CE,RoHS,IP
<b>Ambient temperature</b>	-20°C ~ +45°C
<b>Average life</b>	50,000Hrs
<b>Accessories(Optional)</b>	N/A
<b>Applications</b>	Indoor/Outdoor/Landscape/Submersible



Model No.	LED Brand	Color	Beam	PowerMode	Input	Wiring	Cable	Power	Luminous Flux	Dimension	DrillSize
LP023-2L	CCREE	RGB,CW,WW, NW Red,Green,Blue,Amber	S20/F60	Constant current	350mA	Series	3M 2X0.75mm <sup>2</sup> Cable	3W	300LM	70x70x300	N/A
LP023D-2L	CREE	CW,WW, NW Red,Green,Blue,Amber	S20/F60	Constant voltage	12/24VDC	Parallel	3M 2X0.75mm <sup>2</sup> Cable	3.5W	300LM	70x70x300	N/A
LP023-5L	CREE	RGB,CW,WW, NW Red,Green,Blue,Amber	S20/F60	Constant current	350mA	Series	3M 2X0.75mm <sup>2</sup> Cable	3W	300LM	70x70x600	N/A
LP0230-5L	CREE	CW,WW, NW Red,Green,Blue,Amber	S20/F60	Constant voltage	12/24VDC	Parallel	3M 2X0.75mm <sup>2</sup> Cable	3.5W	300LM	70x70x600	N/A

\*IES Data support.

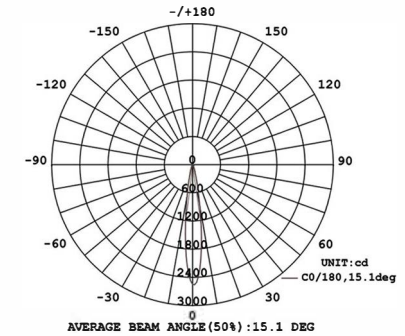
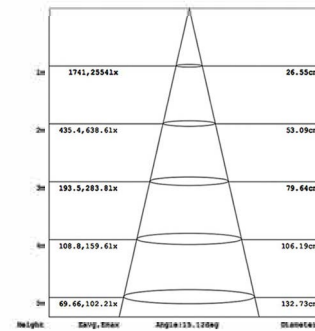



## LP021 SPOT LIGHT



### LED Colours



### LP021

Marine grade 316 stainless steel miniature surface mounted fixture complete with integral CREE LED package. Tempered glass, fixture rated to IP68 allowing submersion in water thus negating common issues arising from lack of soil drainage. 12/45 degree beam options. No mechanical joints to light source ensures robust protection against water ingress. Product runs cool meeting all touch temperature requirements. Ideal as a surface mounted miniature marker light

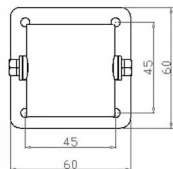
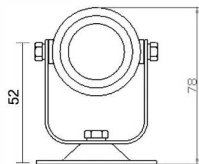

### DESCRIPTION

<b>LED Light source</b>	High Power LED
<b>Light Color</b>	RGB, CW, WW, NW, Red, Green, Blue, Amber
<b>Material</b>	SUS316
<b>Optics</b>	S12° / F45°
<b>Power</b>	1W
<b>Power supply</b>	N/A
<b>Dimension</b>	60X60X78
<b>Weight</b>	500g
<b>IP Rating</b>	IP68
<b>Approvals</b>	CE, RoHS, IP
<b>Ambient temperature</b>	-20°C ~ +45°C
<b>Average life</b>	50,000Hrs
<b>Accessories(Optional)</b>	N/A
<b>Applications</b>	Indoor / Outdoor / Landscape / Submersible



Model No.	LED Brand	Color	Beam	PowerMode	Input	Wiring	Cable	Power	Luminous Flux	Dimension	DrillSize
LP021	CREE	CW, WW, NW, Red, Green, Blue, Amber	12/45	Constant current	350mA	Series	3M 2X0.75mm <sup>2</sup> Cable	1W	100LM	60X60X78	N/A
LP021D	CREE	CW, WW, NW, Red, Green, Blue, Amber	12/45	Constant voltage	24VDC	Parallel	3M 2X0.75mm <sup>2</sup> Cable	1.3W	100LM	60X60X78	N/A
LP021RGB	Edison	RGB	45	Constant current	350mA	Series	2x3M 4X0.5mm <sup>2</sup> Cable	3W	N/A	60X60X78	N/A
LP021DMX-RGB	Edison	RGB	45	Constant voltage	24VDC DMX Controller	Parallel	1.1M 4X0.5mm <sup>2</sup> Cable	3.5W	N/A	60X60X78	N/A

DMX decoder in built

\*IES Data support.

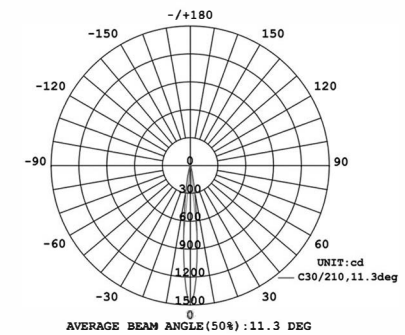
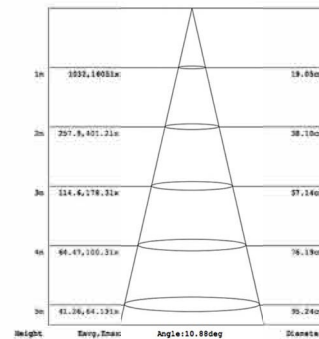

## LP026 SPOT LIGHT



### LED Colours



White 3000K   White 4000K   White 6000K   RGB

### LP026

Marine Grade 316 stainless steel miniature surface mounted fixture complete with integral CREE LED package. Tempered glass, fixture rated to IP68 allowing submersion in water thus negating common issues arising from lack of soil drainage. 10/40 degree beam options. No mechanical joints to light source ensures robust protection against water ingress. Product runs cool meeting all touch temperature requirements. Ideal as a surface mounted miniature marker light.

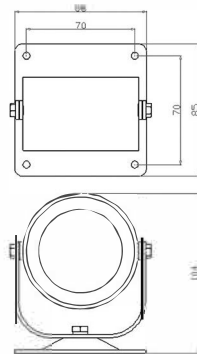

### DESCRIPTION

<b>LED Light source</b>	High Power LED
<b>Light Color</b>	RGB,CW,WW,NW,Red,Green,Blue,Amber
<b>Material</b>	SUS316
<b>Optics</b>	S10° / F40°
<b>Power</b>	6W
<b>Power supply</b>	N/A
<b>Dimension</b>	85X85X104
<b>Weight</b>	1.05kg
<b>IP Rating</b>	IP68
<b>Approvals</b>	CE, RoHS, IP
<b>Ambient temperature</b>	-20°C ~ +45°C
<b>Average life</b>	50,000Hrs
<b>Accessories(Optional)</b>	N/A
<b>Applications</b>	Indoor/Outdoor/Landscape/Submersible



Model No.	LED Brand	Color	Beam	PowerMode	Input	Wiring	Cable	Power	Luminous Flux	Dimension	DrillSize
LP026	CREE	CW,WW, NW,Red Green,Blue,Amber	S10/F40	Constant current	350mA	Series	3M 2X0.75mm <sup>2</sup> Cable	6W	500LM	85X85X104	N/A
LP026D	CREE	CW,WW, NW,Red Green,Blue,Amber	S10/F40	Constant voltage	24VDC	Parallel	3M 2X0.75mm <sup>2</sup> Cable	6.5W	500LM	85X85X104	N/A
LP026RGB	CREE	2R+2G+2B	S10/F40	Constant current	350mA	Series	2x3M 4X0.5mm <sup>2</sup> Cable	6W	N/A	85X85X104	N/A
LP026DMX-RGB	CREE	2R+2G+2B	S10/F40	Constant voltage	24VDC DMX Controller	Parallel	1.1M 4X0.5mm <sup>2</sup> Cable	6.5W	N/A	85X85X104	N/A
LP026DMX-RGB	Edison	RGB(Fullcolor)	S10/F40	Constant voltage	24VDC DMX Controller	Parallel	1.1M 4X0.5mm <sup>2</sup> Cable	6.5W	N/A	85X85X104	N/A
LP026DMX-RGBW	Edison	RGBW(Fullcolor)	S10/F40	Constant voltage	24VDC DMX Controller	Parallel	1.1M 4X0.5mm <sup>2</sup> Cable	6.5W	N/A	85X85X104	N/A

DMX decoder in built

\*IES Data support.

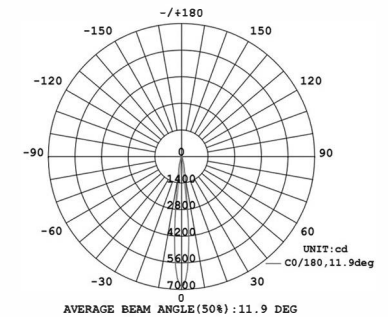
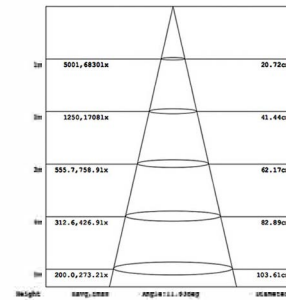





# GROUND LIGHT

SPECIALIZED MANUFACTURER  
LED LIGHTING PRODUCTS



## LP 100 GROUND LIGHT



### LED Colours



White 3000K    White 4000K    White 6000K

### LP 100

Marine grade 316 stainless steel surface mounted fixture complete with high power CREE LED package. Tempered glass, fixture rated to IP68 allowing to use on yachts, ships. With high strength, extra-thick tempered glass, the product has an IK10 (protection against shock up to 20 joules). Able to withstand harsh environments. Maximum hull thickness: < 100mm (~ 3.9")

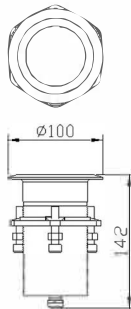

### DESCRIPTION

LED Light source	High Power LED
Light Color	RGB,CW,WW,NW,Red,Green,Blue,Amber
Material	SUS316
Optics	F40°
Power	15W / 20W
Power supply	12VDC(12-30VDC)
Dimension	D100X142
Weight	1650g
IP Rating	IP68
Approvals	CE,RoHS,IP
Ambient temperature	-20°C ~ +45°C
Average life	50,000Hrs
Accessories(Optional)	N/A
Applications	Indoor/Outdoor/Landscape/ Submersible/Yachting
Optional brand	CREE



Model No.	LED Brand	Color	Beam	PowerMode	Input	Wiring	Cable	Power	Luminous Flux	Dimension	DrillSize
LP 100D	CREE	CW	F40	Constant voltage	12VDC	Parallel	1.1M 2X0.75mm <sup>2</sup> Cable	20W	1500LM	D100X142	D75
LP 100D	CREE	Blue	F40	Constant voltage	12VDC	Parallel	1.1M 2X0.75mm <sup>2</sup> Cable	15W	500LM	D100X142	D75

\*IES Data support.

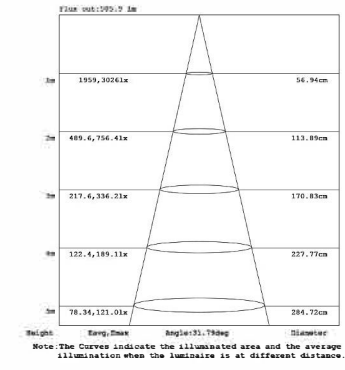
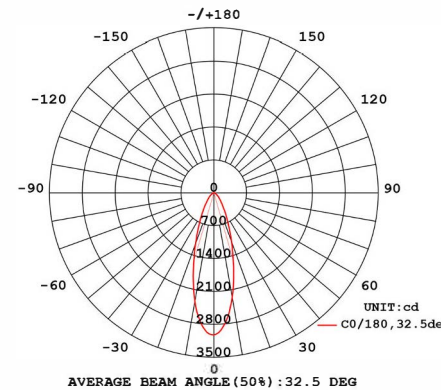



LP310 GROUND LIGHT



DESCRIPTION

<b>LED Light source</b>	High Power LED
<b>Light Color</b>	RGB,CW,WW,NW,Red,Green,Blue,Amber
<b>Material</b>	SUS316(Lamp cap)+Aluminum(Lamp cup)
<b>Optics</b>	15° / S20° / 30° / 45° / F60*
<b>Power</b>	12W
<b>Power supply</b>	350mA or 24VDC
<b>Dimension</b>	550X76Xh29
<b>Weight</b>	N/A
<b>IP Rating</b>	IP67
<b>Approvals</b>	CE,RoHS,IP
<b>Ambient temperature</b>	-20°C ~ +45°C
<b>Accessories(Optional)</b>	N/A
<b>Applications</b>	Indoor/Outdoor

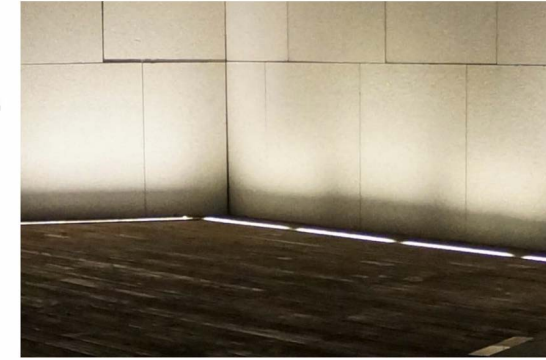

LED Colours

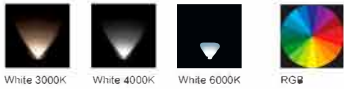

LP310

Recessed linear fixture rated to IP67. 15/20/30/45/60 degree beam options. Wall/ floor-recessed luminaire for use with fluorescent lamps and LEDs. Tempered glass with integrated CREE XPE LED chipset. Luminaire ready for pass-through wiring.

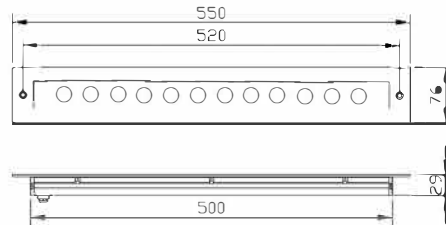

Model No.	LED Brand	Color	Beam	PowerMode	Input	Wiring	Cable	Power	Luminous Flux	Dimension	DrillSize
LP310	CREE	CW,WW,NW,Red Green,Blue,Amber	15/S20/30/45/F60	Constant current	350mA	Series	0.5M 2X0.75mm <sup>2</sup> Cable or 0.2M Plug	12W	800LM	550X75XH29	505X60
LP310D	CREE	CW,WW,NW,Red Green,Blue,Amber	15/S20/30/45/F60	Constant voltage	24VDC	Parallel	0.5M 2X0.75mm <sup>2</sup> Cable or 0.2M Plug	13W	800LM	550X75XH29	505X60
LP310M	CREE	CW,WW,NW,Red Green,Blue,Amber	120	Constant current	350mA	Series	0.5M 2X0.75mm <sup>2</sup> Cable or 0.2M Plug	12W	500LM	550X75XH29	505X60
LP310DM	CREE	CW,WW,NW,Red Green,Blue,Amber	120	Constant voltage	24VDC	Parallel	0.5M 2X0.75mm <sup>2</sup> Cable or 0.2M Plug	13W	500LM	550X75XH29	505X60
LP310RGB	CREE	4R+4G+4B	15/S20/30/45/F60	Constant current	350mA	Series	0.5M 4X0.5mm <sup>2</sup> Cable or 0.2M Plug	12W	N/A	550X75XH29	505X60
LP310DMX-RGB	Edison	RGB(Fullcolor)	15/S20/30/45/F60	Constant voltage	24VDC DMX Controller	Parallel	0.5M 4X0.5mm <sup>2</sup> Cable or 0.2M Plug	13W	N/A	550X75XH29	505X60

DMX decoder in built

\*IES Data support.  
\*Length and power could be customized.

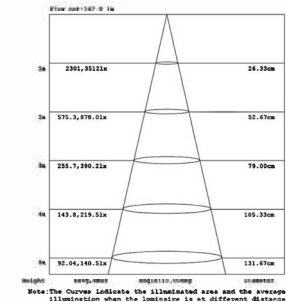
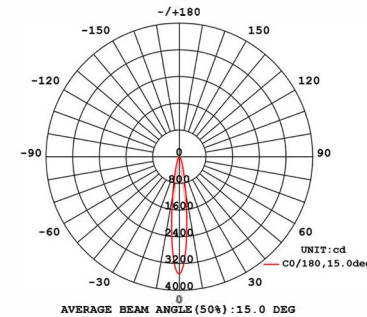

## LP240 GROUND LIGHT



### LED Colours



### LP240

Marine grade 316 stainless steel bezel panel with aluminum lamp body. Tempered glass, In-ground floodlight fixture complete with integral CREE LED package. 10/20/40/60 degree beam options. No mechanical joints to light source ensures robust protection against water ingress. Product runs cool meeting all touch temperature requirements. Suitable for the illumination of small/medium trees.

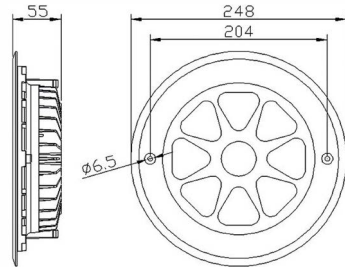

### DESCRIPTION

<b>LED Light source</b>	High Power LED
<b>Light Color</b>	RGB,CW,WW,NW,Red,Green,Blue,Amber
<b>Material</b>	SUS316(Lamp cap)+Aluminum(Lamp cup)
<b>Optics</b>	10° / S20° / 40° / F60°
<b>Power</b>	24W
<b>Power supply</b>	N/A
<b>Dimension</b>	D248X55
<b>Weight</b>	3.25kg
<b>IP Rating</b>	IP67
<b>Approvals</b>	CE,RoHS,IP
<b>Ambient temperature</b>	-20°C ~ +45°C
<b>Average life</b>	50,000Hrs
<b>Accessories(Optional)</b>	Yes
<b>Applications</b>	Indoor/Outdoor/Landscape/Submersible



Model No.	LED Brand	Color	Beam	PowerMode	Input	Wiring	Cable	Power	Luminous Flux	Dimension	DrillSize
LP240	CREE	CW,WW, NW,Red,Green,Blue,Amber	10/S20/40/F60	Constant current	350mA	Series	3M 2X0.75mm <sup>2</sup> Cable	24W	2200LM	D248X55	D225
LP240D	CREE	CW,WW, NW,Red,Green,Blue,Amber	10/S20/40/F60	Constant voltage	24VDC	Parallel	3M 2X0.75mm <sup>2</sup> Cable	26W	2200LM	D248X55	D225
LP240DM	OSRAM	CW,WW, NW,Red,Green,Blue,Amber	120	Constant voltage	24VDC	Parallel	3M 2X0.75mm <sup>2</sup> Cable	18W	1400LM	D248X55	D225
LP240RGB	CREE	8R+8G+8B	10/S20/40/F60	Constant current	350mA	Series	2x3M 4X0.5mm <sup>2</sup> Cable	24W	N/A	D248X55	D225
LP240DMX-RGB	CREE	8R+8G+8B	10/S20/40/F60	Constant voltage	24VDC DMX Controller	Parallel	1.1M 4X0.5mm <sup>2</sup> Cable	26W	N/A	D248X55	D225

DMX decoder in built

\*IES Data support.

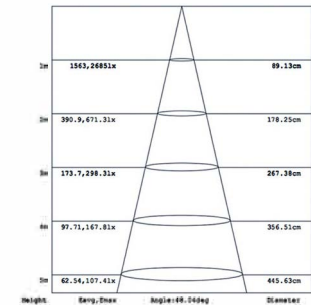
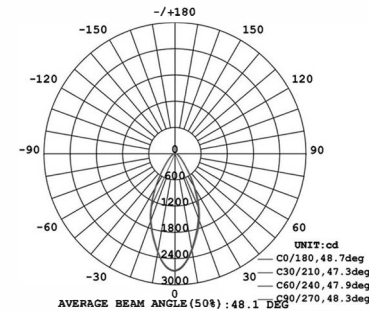



## LP180 GROUND LIGHT



### LED Colours



### LP180

Marine grade 316 stainless steel bezel panel with aluminum lamp body. Tempered glass, this fixture complete with integral CREE LED package. Fixture rated to IP68 with no mechanical joints to light source ensuring robust protection against water ingress. 10/20/40/60 degree beam options. Product runs cool meeting all touch temperature requirements. Suitable for the illumination of small/medium trees.

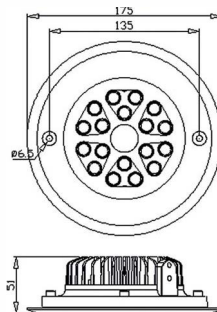

### DESCRIPTION

<b>LED Light source</b>	High Power LED
<b>Light Color</b>	RGB,CW,WW,NW,Red,Green,Blue,Amber
<b>Material</b>	SUS316(Lamp cap)+Aluminium(Lamp cup)
<b>Optics</b>	10° / S20° / 40° / F60°
<b>Power</b>	18W
<b>Power supply</b>	N/A
<b>Dimension</b>	D175X51
<b>Weight</b>	1.7KG
<b>IP Rating</b>	IP67
<b>Approvals</b>	CE,RoHS,IP
<b>Ambient temperature</b>	-20°C ~ +45°C
<b>Average life</b>	50,000Hrs
<b>Accessories(Optional)</b>	Yes
<b>Applications</b>	Indoor / Outdoor / Landscape / Submersible



Model No.	LED Brand	Color	Beam	PowerMode	Input	Wiring	Cable	Power	Luminous Flux	Dimension	DrillSize
LP180	CREE	CW,WW, NW,Red,Green,Blue,Amber	10/S20/40/F60	Constant current	350mA	Series	3M 2X0.75mm <sup>2</sup> Cable	18W	1700LM	D175X51	D155
LP180D	CREE	CW,WW, NW,Red,Green,Blue,Amber	10/S20/40/F60	Constant voltage	24VDC	Parallel	3M 2X0.75mm <sup>2</sup> Cable	20W	1700LM	D175X51	D155
LP180RGB	CREE	6R+6G+6B	10/S20/40/F60	Constant current	350mA	Series	2x3M 4X0.5mm <sup>2</sup> Cable	18W	N/A	D175X51	D155
LP180DMX-RGB	CREE	6R+6G+6B	10/S20/40/F60	Constant voltage	24VDC DMX Controller	Parallel	1.1M 4X0.5mm <sup>2</sup> Cable	20W	N/A	D175X51	D155
LP180DMX-RGB	Edison	RGB(Fullcolor)	10/S20/40/F60	Constant voltage	24VDC DMX Controller	Parallel	1.1M 4X0.5mm <sup>2</sup> Cable	20W	N/A	D175X51	D155
LP180DMX-RGBW	Edison	HGBW(Fullcolor)	10/S20/40/F60	Constant voltage	24VDC DMX Controller	Parallel	1.1M 4X0.5mm <sup>2</sup> Cable	20W	N/A	D175X51	D155

DMX decoder in built

\*IES Data support.

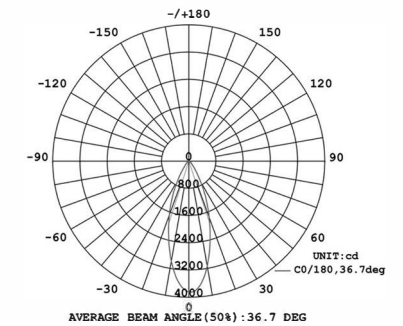
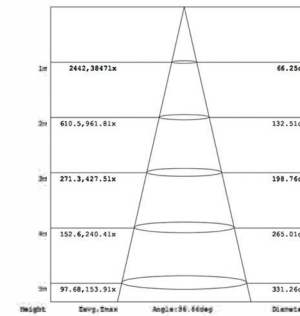

## LP120 GROUND LIGHT



### LED Colours



### LP120

Marine grade 316 stainless steel bezel panel with aluminum lamp body. Tempered glass, this fixture complete with integral CREE LED package. Fixture rated to IP68 with no mechanical joints to light source ensuring robust protection against water ingress. 10/20/40/60 degree beam options. Product runs cool meeting all touch temperature requirements. Suitable for the illumination of small/medium trees.

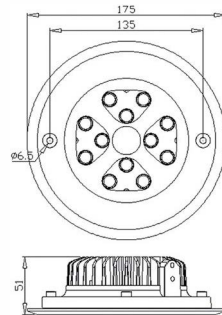

### DESCRIPTION

<b>LED Light source</b>	High Power LED
<b>Light Color</b>	RGB,CW,WW,NW,Red,Green,Blue,Amber
<b>Material</b>	SUS316(Lamp cap)+Aluminium(Lamp cup)
<b>Optics</b>	10° / S20° / 40° / F60°
<b>Power</b>	12W
<b>Power supply</b>	N/A
<b>Dimension</b>	D175X51
<b>Weight</b>	1.7KG
<b>IP Rating</b>	IP67
<b>Approvals</b>	CE,RoHS,IP
<b>Ambient temperature</b>	-20°C ~ +45°C
<b>Average life</b>	50,000Hrs
<b>Accessories(Optional)</b>	Yes
<b>Applications</b>	Indoor/Outdoor/Landscape



Model No.	LED Brand	Color	Beam	PowerMode	Input	Wiring	Cable	Power	Luminous Flux	Dimension	DrillSize
LP120	CREE	CW,WW, NW,Red Green,Blue,Amber	10/S20/40/F60	Constant current	350mA	Series	3M 2X0.75mm <sup>2</sup> Cable	12W	1300LM	D175X51	D155
LP120D	CREE	CW,WW, NW,Red Green,Blue,Amber	10/S20/40/F60	Constant voltage	24VDC	Parallel	3M 2X0.75mm <sup>2</sup> Cable	13W	1300LM	D175X51	D155
LP120DM	OSRAM	CW,WW, NW,Red Green,Blue,Amber	120	Constant voltage	24VDC	Parallel	3M 2X0.75mm <sup>2</sup> Cable	12W	650LM	D175X51	D155
LP120RGB	CREE	4R+4G+4B	10/S20/40/F60	Constant current	350mA	Series	2x3M 4X0.5mm <sup>2</sup> Cable	12W	N/A	D175X51	D155
LP 120DMX-RGB	CREE	4R+4G+4B	10/S20/40/F60	Constant voltage	4VDC DMX Controller	Parallel	1.1M 4X0.5mm <sup>2</sup> Cable	13W	N/A	D175X51	D155
LP 120DMX-RGB	Edison	RGB(Fullcolor)	10/S20/40/F60	Constant voltage	24VDC DMX Controller	Parallel	1.1M 4X0.5mm <sup>2</sup> Cable	13W	N/A	D175X51	D155
LP 120DMX-RGBW	Edison	RGBW(Fullcolor)	10/S20/40/F60	Constant voltage	24VDC DMX Controller	Parallel	1.1M 4X0.5mm <sup>2</sup> Cable	13W	N/A	D175X51	D155

DMX decoder in built

\*IES Data support

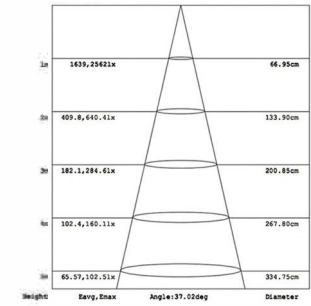
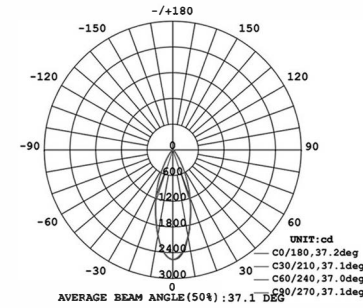



# LP080 GROUND LIGHT



### LED Colours



White 3000K White 4000K White 6000K RGB

### LP080

Marine grade 316 stainless steel bezel panel with aluminum lamp body. This fixture complete with integral CREE LED package. Tempered glass, fixture rated to IP67 with no mechanical joints to light source ensuring robust protection against water ingress. 10/20/40/60 degree beam options. Product runs cool meeting all touch temperature requirements. Suitable for the illumination of small/medium trees.

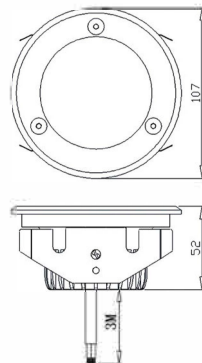

### DESCRIPTION

<b>LED Light source</b>	High Power LED
<b>Light Color</b>	RGB,CW,WW,NW,Red,Green,Blue,Amber
<b>Material</b>	SUS316(Lamp cap)+Aluminium(Lamp cup)
<b>Optics</b>	10° / S20° / 40° / F60°
<b>Power</b>	6x1W
<b>Power supply</b>	N/A
<b>Dimension</b>	D107x52
<b>Weight</b>	1.1KG
<b>IP Rating</b>	IP67
<b>Approvals</b>	CE,RoHS,IP
<b>Ambient temperature</b>	-20°C ~ +45°C
<b>Average life</b>	50,000Hrs
<b>Accessories(Optional)</b>	N/A
<b>Applications</b>	Indoor/Outdoor/Landscape

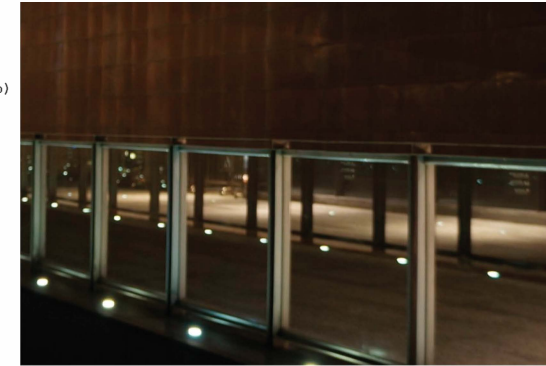

Model No.	LED Brand	Color	Beam	PowerMode	Input	Wiring	Cable	Power	Luminous Flux	Dimension	DrillSize
LP080	CREE	CW,WW, NW,Red Green,Blue,Amber	S10/F40	Constant current	350mA	Series	3M 2X0.75mm2 Cable	6W	500LM	D107X52	D95
LP080D	CREE	CW,WW, NW,Red Green,Blue,Amber	S10/F40	Constant voltage	24VDC	Parallel	3M 2X0.75mm2 Cable	6.5W	500LM	D107X52	D95
LP080-3W	CREE	CW,WW, NW,Red Green,Blue,Amber	10/S20/40/F60	Constant current	350mA	Series	3M 2X0.75mm2 Cable	3W	300LM	D107X52	D95
LP080D-3W	CREE	CW,WW, NW,Red Green,Blue,Amber	10/S20/40/F60	Constant voltage	24VDC	Parallel	3M 2X0.75mm2 Cable	3.5W	300LM	D107X52	D95
LP080M	CREE	CW,WW, NW,Red Green,Blue,Amber	120	Constant current	350mA	Series	3M 2X0.75mm2 Cable	6W	500LM	D107X52	D95
LP080RGB	CREE	2R+2G+2B	S10/F40	Constant current	350mA	Series	2x3M 4X0.5mm2 Cable	6W	N/A	D107X52	D95
LP080DMX-RGB	CREE	2R+2G+2B	S10/F40	Constant voltage	24VDC DMX Controller	Parallel	1.1M 4X0.5mm2 Cable	6.5W	N/A	D107X52	D95
LP080DMX-RGB	Edison	RGB(Fullcolor)	S10/F40	Constant voltage	24VDC DMX Controller	Parallel	1.1M 4X0.5mm2 Cable	6.5W	N/A	D107X52	D95
LP080DMX-RGBW	Edison	RGBW(Fullcolor)	S10/F40	Constant voltage	24VDC DMX Controller	Parallel	1.1M 4X0.5mm2 Cable	6.5W	N/A	D107X52	D95

DMX decoder in built

\*IES Data support.

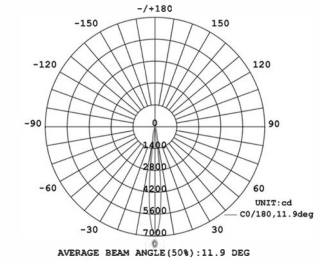
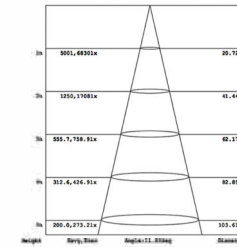

## LP112 GROUND LIGHT



### LED Colours



White 3000K White 4000K White 6000K RGB

### LP112

Miniature recessed fixture complete with integral CREE LED package and 20/60 degree beam options. Marine Grade 316 Stainless Steel option with construction rated to IP68. Tempered glass, with patented cable waterproof design. Product footprint of 23mm diameter ensures versatile application. Inline driver options include switched, 1-10V and DALI dimmable solutions.

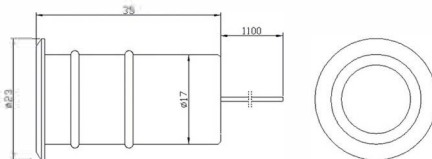

### DESCRIPTION

<b>LED Light source</b>	High Power LED
<b>Light Color</b>	RGB,CW,WW,NW,Red,Green,Blue,Amber
<b>Material</b>	SUS316
<b>Optics</b>	S20° / F60°
<b>Power</b>	1W
<b>Power supply</b>	N/A
<b>Dimension</b>	D23X35
<b>Weight</b>	50g
<b>IP Rating</b>	IP68
<b>Approvals</b>	CE,RoHS,IP
<b>Ambient temperature</b>	-20°C ~ +45°C
<b>Average life</b>	50,000Hrs
<b>Accessories(Optional)</b>	N/A
<b>Applications</b>	Indoor/Outdoor/Landscape/Submersible



Model No.	LED Brand	Color	Beam	PowerMode	Input	Wiring	Cable	Power	Luminous Flux	Dimension	DrillSize
LP112	CREE	CW,WW, NW,Red Green,Blue,Amber	S20/F60	Constant current	350mA	Series	1.1M 2X24AWG Cable	1W	100LM	D23X35	D19
LP112D	CREE	CW,WW, NW,Red Green,Blue,Amber	S20/F60	Constant voltage	24VDC	Parallel	1.1M 2X24AWG Cable	1.3W	100LM	D23X40	D19
LP112M	CREE/OSRAM	CW,WW, NW,Red Green,Blue,Amber	120	Constant voltage	12VDC	Parallel	1.1M 2X24AWG Cable	0.5W	30LM	D23X40	D19
LP112RGB	Edison	RGB	120	Constant voltage	12VDC	Parallel	1.1M 4X24AWG Cable	0.5W	N/A	D23X35	D19

\*IES Data support.

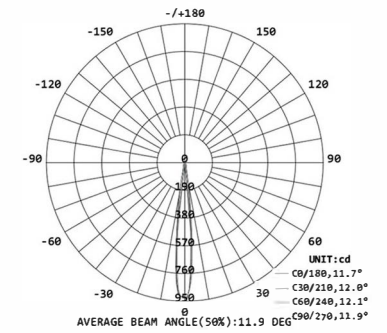
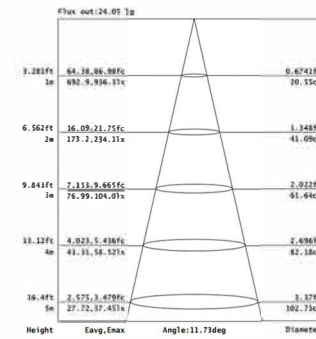



## LP 112H GROUND LIGHT



### DESCRIPTION

<b>LED Light source</b>	High Power LED
<b>Light Color</b>	CW, WW, NW, Red, Green, Blue, Amber
<b>Material</b>	SUS316
<b>Optics</b>	S20° / F60°
<b>Power</b>	1W
<b>Power supply</b>	N/A
<b>Dimension</b>	D23x35
<b>Weight</b>	50g
<b>IP Rating</b>	IP68
<b>Approvals</b>	CE, RoHS, IP
<b>Ambient temperature</b>	-20°C ~ +45°C
<b>Average life</b>	50,000Hrs
<b>Accessories(Optional)</b>	N/A
<b>Applications</b>	Indoor / Outdoor / Landscape / Submersible



#### LED Colours



White 3000K    White 4000K    White 6000K    RGB

### LP 112H

Miniature recessed fixture complete with integral CREE LED package and 20/60 degree beam option. Tempered glass with ultra low-glare, IP68 ground light is made of marine Grade 316 Stainless Steel. Product footprint of 23mm diameter ensures versatile application. Inline driver options include switched, 1-10V and DALI dimmable solutions.

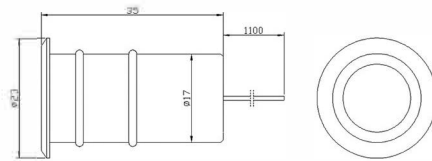

Model No.	LED Brand	Color	Beam	PowerMode	Input	Wiring	Cable	Power	Luminous Flux	Dimension	DrillSize
LP 112H	CREE	CW, WW, NW, Red, Green, Blue, Amber	S20/F60	Constant current	350mA	Series	1.1M 2X24AWG Cable	1W	100LM	D23x35	D19
LP 112HD	CREE	CW, WW, NW, Red, Green, Blue, Amber	S20/F60	Constant voltage	24VDC	Parallel	1.1M 2X24AWG Cable	1.3W	100LM	D23x41	D19

\*IES Data support.

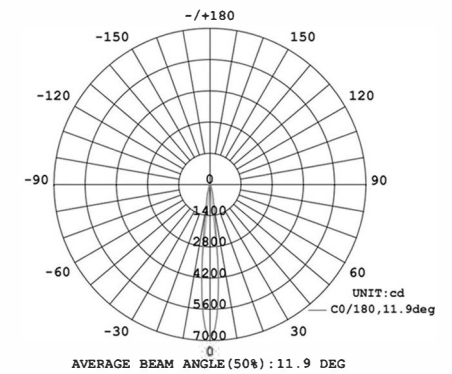
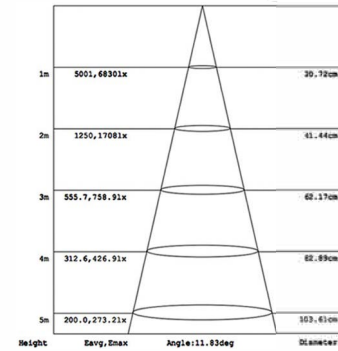

## LP116 GROUND LIGHT



GL116C



Optional accessories

### LED Colours

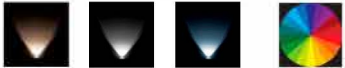

White 3000K White 4000K White 6000K RGB

### LP116

Miniature recessed fixture complete with integral CREE LED package and 12/45 degree beam options. Tempered glass, marine grade 316 Stainless Steel construction rated to IP68. Product footprint of 60mm diameter ensures versatile application. Inline driver options include switched, 1-10V and DALI dimmable solutions.

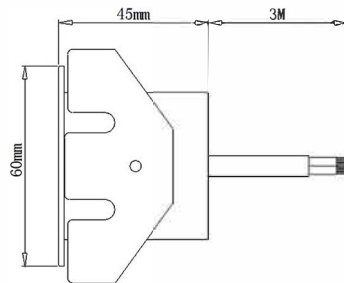

### DESCRIPTION

<b>LED Light source</b>	High Power LED
<b>Light Color</b>	RGB,CW,WW,NW,Red,Green,Blue,Amber
<b>Material</b>	SUS316
<b>Optics</b>	S12° / F45°
<b>Power</b>	1W
<b>Power supply</b>	N/A
<b>Dimension</b>	D60x45
<b>Weight</b>	465g
<b>IP Rating</b>	IP68
<b>Approvals</b>	CE,RoHS,IP
<b>Ambient temperature</b>	-20°C ~ +45°C
<b>Average life</b>	50,000Hrs
<b>Accessories(Optional)</b>	
<b>Applications</b>	Indoor/Outdoor/Landscape/Submersible



Model No.	LED Brand	Color	Beam	PowerMode	Input	Wiring	Cable	Power	Luminous Flux	Dimension	DrillSize
LP116	CREE	CW,WW, NW,Red,Green,Blue,Amber	S12/F45	Constant current	350mA	Series	3M 2X0.75mm <sup>2</sup> Cable	1W	100LM	D60X45	D50
LP116D	CREE	CW,WW, NW,Red,Green,Blue,Amber	S12/F45	Constant voltage	24VDC	Parallel	3M 2X0.75mm <sup>2</sup> Cable	1.3W	100LM	D60X45	D50
LP116C	CREE	CW,WW, NW,Red,Green,Blue,Amber	S12/F45	Constant current	350mA	Series	3M 2X0.75mm <sup>2</sup> Cable	1W	100LM	D60X45	D50
LP116RGB	Edison	RGB	45	Constant current	350mA	Series	2x3M 4X0.5mm <sup>2</sup> Cable	3W	N/A	D60X45	D50
LP 116DMX-RGB	Edison	RGB	S12/F45	Constant voltage	24VDC DMX	Parallel	1.1M 4X0.5mm <sup>2</sup> Cable	3.5W	N/A	D60X45	D50

DMX decoder in built

\*IES Data support.

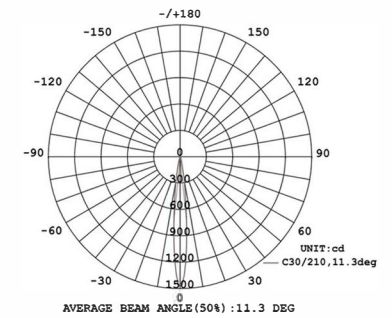
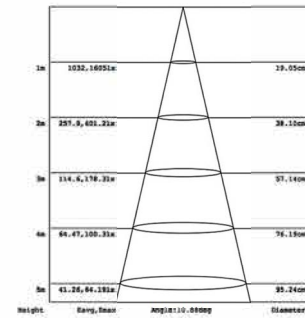



## LP 116H GROUND LIGHT



### LED Colours



### LP116H

Miniature recessed fixture complete with integral CREE LED package and 20/60 degree beam options. Tempered glass, marine grade 316 Stainless Steel option with construction rated to IP68. Recessed light source and black baffle serve to minimize glare. Product footprint of 60mm diameter ensures versatile application. Inline driver options include switched, 1-10V and DALI dimmable solutions.

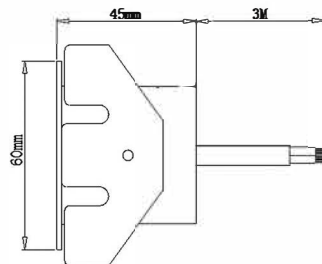

### DESCRIPTION

<b>LED LIGHT SOURCE</b>	High Power LED
<b>LIGHT COLOR</b>	CW, WW, NW, Red, Green, Blue, Amber
<b>MATERIAL</b>	SUS316
<b>OPTICS</b>	S20° / F60°
<b>POWER</b>	1W
<b>POWER SUPPLY</b>	N/A
<b>DIMENSION</b>	D60x45
<b>WEIGHT</b>	465g
<b>IP RATING</b>	IP68
<b>APPROVALS</b>	CE, RoHS, IP
<b>AMBIENT TEMPERATURE</b>	-20°C ~ +45°C
<b>AVERAGE LIFE</b>	50,000Hrs
<b>ACCESSORIES(OPTIONAL)</b>	N/A
<b>APPLICATIONS</b>	Indoor / Outdoor / Landscape / Submersible



Model No.	LED Brand	Color	Beam	PowerMode	Input	Wiring	Cable	Power	Luminous Flux	Dimension	DrillSize
LP116H	CREE	CW, WW, NW, Red, Green, Blue, Amber	S20/F60	Constant current	350mA	Series	3M 2X0.75mm <sup>2</sup> Cable	1W	100LM	D60X45	D50
LP116HD	CREE	CW, WW, NW, Red, Green, Blue, Amber	S20/F60	Constant voltage	24VDC	Parallel	3M 2X0.75mm <sup>2</sup> Cable	1.3W	100LM	D60X45	D50

\*IES Data support.

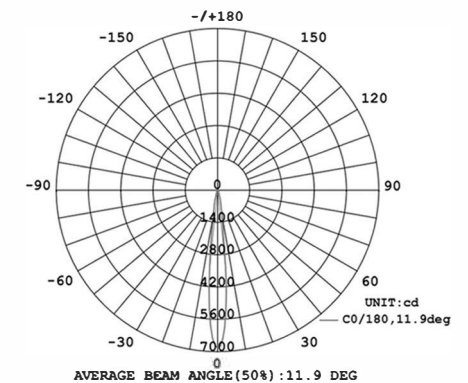
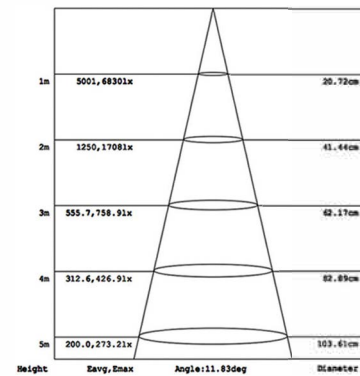

## LP 116Q GROUND LIGHT



TS116  
Optional accessories

### LED Colours



### LP 116Q

Miniature recessed fixture complete with integral CREE LED package and S25X45/F20X50 degree beam options. Tempered glass, marine grade 316 Stainless Steel option with construction rated to IP68. Recessed light source and black baffle serve to minimize glare. Product footprint of 60mm diameter ensures versatile application. In-line driver options include switched, 1-10V and DALI dimmable solutions. Side-entry option also available.

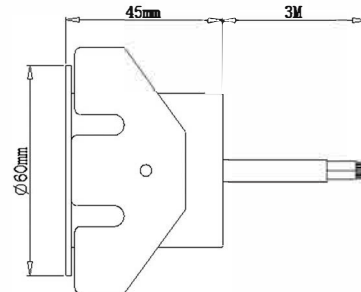

### DESCRIPTION

<b>LED Light source</b>	High Power LED
<b>Light Color</b>	CW, WW, NW, Red, Green, Blue, Amber
<b>Material</b>	SUS316
<b>Optics</b>	S25X40° / F20X50°
<b>Power</b>	1W
<b>Power supply</b>	N/A
<b>Dimension</b>	ø60x45
<b>Weight</b>	465g
<b>IP Rating</b>	IP68
<b>Approvals</b>	CE, RoHS, IP
<b>Ambient temperature</b>	-20°C ~ +45°C
<b>Average life</b>	50,000Hrs
<b>Accessories(Optional)</b>	
<b>Applications</b>	Indoor/Outdoor/Landscape/Submersible



Model No.	LED Brand	Color	Beam	PowerMode	Input	Wiring	Cable	Power	Luminous Flux	Dimension	DrillSize
LP 116Q	CREE	CW, WW, NW, Red, Green, Blue, Amber	S25X40/F20X50	Constant current	350mA	Series	3M 2X0.75mm <sup>2</sup> Cable	1W	100LM	D60X45	D50
LP 116QD	CREE	CW, WW, NW, Red, Green, Blue, Amber	S25X40/F20X50	Constant voltage	24VDC	Parallel	3M 2X0.75mm <sup>2</sup> Cable	1.3W	100LM	D60X45	D50

\*IES Data support.

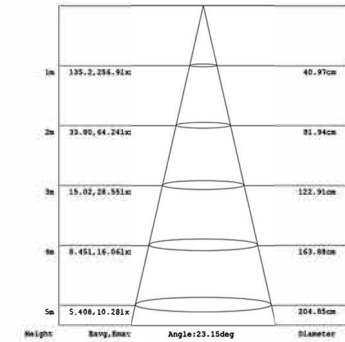
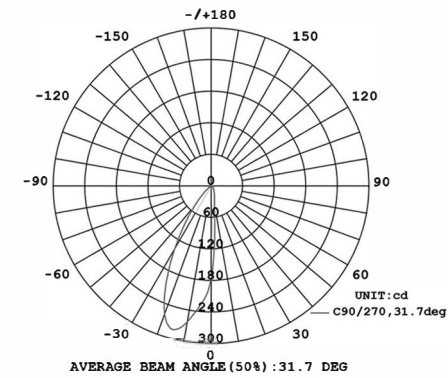



## LP 116SQ GROUND LIGHT

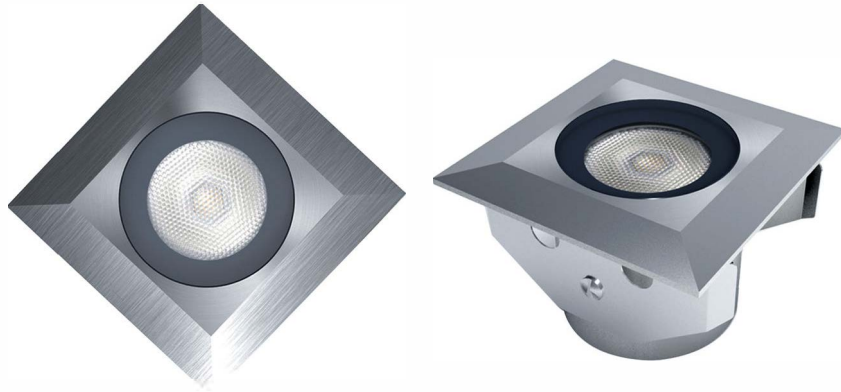

### LED Colours



### LP 116SQ

Square recessed fixture complete with integral CREE LED package and 12/45 degree beam options. Tempered glass, marine grade 316 Stainless Steel option with construction rated to IP68. Small Product footprint ensures versatile application. Inline driver options include switched, 1-10V and DALI dimmable solutions.

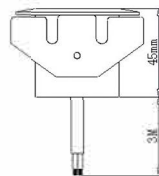
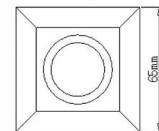

### DESCRIPTION

<b>LED LIGHT SOURCE</b>	High Power LED
<b>LIGHT COLOR</b>	RGB,CW,WW,NW,Red,Green,Blue,Amber
<b>MATERIAL</b>	SUS316
<b>OPTICS</b>	S12° / F45°
<b>POWER</b>	1W
<b>POWER SUPPLY</b>	N/A
<b>DIMENSION</b>	65x65x45
<b>WEIGHT</b>	490g
<b>IP RATING</b>	IP68
<b>APPROVALS</b>	CE,RoHS,IP
<b>AMBIENT TEMPERATURE</b>	-20°C ~ +45°C
<b>AVERAGE LIFE</b>	50,000Hrs
<b>ACCESSORIES(OPTIONAL)</b>	N/A
<b>APPLICATIONS</b>	Indoor/Outdoor/Landscape/Submersible



Model No.	LED Brand	Color	Beam	PowerMode	Input	Wiring	Cable	Power	Luminous Flux	Dimenton	DrillSize
LP 116SQ	CREE	CW,WW, NW,Red Green,Blue,Amber	S12/F45	Constant current	350mA	Series	3M 2X0.75mm <sup>2</sup> Cable	1W	100LM	65x65x45	D50
LP 116SQD	CREE	CW,WW, NW,Red Green,Blue,Amber	S12/F45	Constant voltage	24VDC	Parallel	3M 2X0.75mm <sup>2</sup> Cable	1.3W	100LM	65x65x45	D50
LP 116SQ-RGB	Edison	RGB	45	Constant current	350mA	Series	2x3M 4X0.5mm <sup>2</sup> Cable	3W	N/A	65x65x45	D50
LP 116SQ-DMX-RGB	Edison	RGB	S12/F45	Constant voltage	24VDC DMX Controller	Parallel	1.1M 4X0.5mm <sup>2</sup> Cable	3.5W	N/A	65x65x45	D50

DMX decoder in built

\*IES Data support.

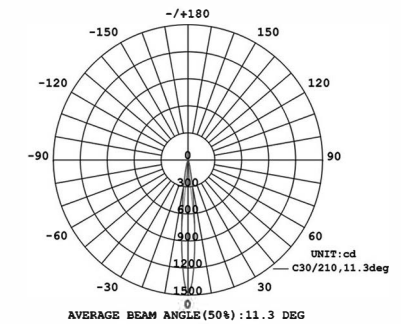
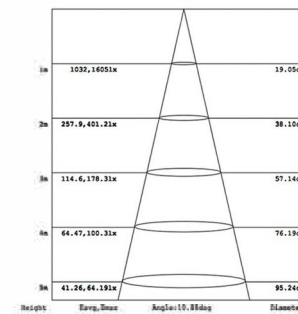

## LP48SQ GROUND LIGHT

### DESCRIPTION

<b>LED Light source</b>	High Power LED
<b>Light Color</b>	CW,WW,NW,Red,Green,Blue,Amber
<b>Material</b>	Aluminium + Frosted glass
<b>Optics</b>	120°
<b>Power</b>	5W
<b>Power supply</b>	N/A
<b>Dimension</b>	48X48X67
<b>Weight</b>	N/A
<b>IP Rating</b>	!P65
<b>Approvals</b>	CE,RoHS,IP
<b>Ambient temperature</b>	-20°C ~ +45°C
<b>Average life</b>	50,000Hrs
<b>Accessories(Optional)</b>	N/A
<b>Applications</b>	Indoor,Outdoor,Exterior wall of building, Ceiling



Model No.	LED Brand	Color	Beam	PowerMode	Input	Wiring	Cable	Power	Luminous Flux	Dimension	DrillSize
LP485QD	OSRAM	CW,WW, NW,Red Green,Blue,Amber	120	Constant voltage	24VDC	Parallel	3M 2X0.75mm <sup>2</sup> Cable	5W	100LM	48X48X67	D40
LP48SQ-DMX	OSRAM	CW,WW, NW,Red Green,Blue,Amber	120	Constant voltage	24VDC DMX Controller	Parallel	1.1M 5X0.5mm <sup>2</sup> Cable	5W	100LM	48X48X67	D40

#### LED Colours



White 3000K    White 4000K    White 6000K

### LP48SQ

Square recessed fixture complete with integral CREE LED package. Aluminum surface mounted projector. Tempered glass, frosted optic serves to minimize glare coupled with 120 degree beam option. Small Product footprint ensures versatile application.

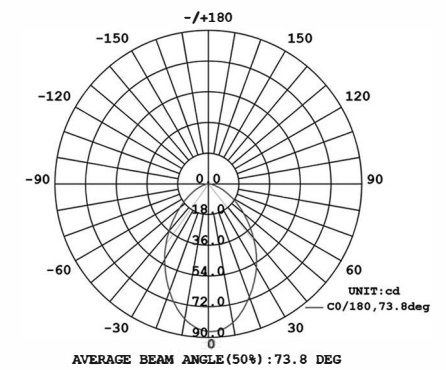
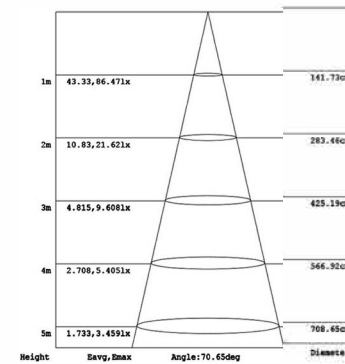
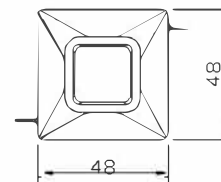
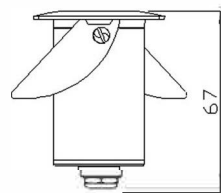

DMX decoder in built

\*IES Data support.





## LP118 GROUND LIGHT



TS118  
Optional accessories

### LED Colours



### LP118

Miniature recessed fixture complete with integral OSRAM LED package. Tempered glass, frosted optic serves to minimize glare coupled with a diffuse beam distribution. Marine Grade 316 Stainless Steel option with construction rated to IP68. Product footprint of 36mm diameter ensures versatile application

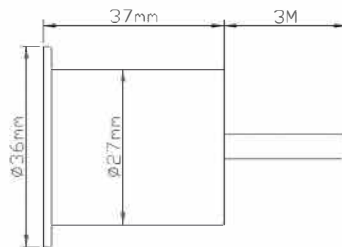

### DESCRIPTION

<b>LED Light source</b>	LED
<b>Light Color</b>	RGB, CW, WW, NW, Red, Green, Blue, Amber
<b>Material</b>	SUS316 / Brass
<b>Optics</b>	120°
<b>Power</b>	1W
<b>Power supply</b>	N/A
<b>Dimension</b>	D36X37
<b>Weight</b>	260g
<b>IP Rating</b>	IP68
<b>Approvals</b>	CE, RoHS, IP
<b>Ambient temperature</b>	-20°C ~ +45°C
<b>Average life</b>	50,000Hrs
<b>Accessories(Optional)</b>	N/A
<b>Applications</b>	Indoor / Outdoor / Landscape / Submersible



MODEL NO.	LED Brand	Color	BEAM	PowerMode	Input	Wiring	Cable	Power	Luminous Flux	Dimension	DrillSize	Material
LP118	OSRAM	CW, WW, NW, Red, Green, Blue, Amber	120	Constant voltage	12/24VDC	Parallel	3M 2X0.75mm <sup>2</sup> Cable	1W	20LM	D36X37	D29	SUS316
LP118AB	OSRAM	CW, WW, NW, Red, Green, Blue, Amber	120	Constant voltage	12/24VDC	Parallel	3M 2X0.75mm <sup>2</sup> Cable	1W	20LM	D36X37	D29	Brass
LP118RGB	EDISON	RGB	120	Constant voltage	RGB24VDC	Parallel	1.1M 4X24AWG Cable	1W	N/A	D36X37	D29	SUS316
LP118AB RGB	EDISON	RGB	120	Constant voltage	RGB24VDC	Parallel	1.1M 4X24AWG Cable	1W	N/A	D36X37	D29	Brass

\*IES Data support.

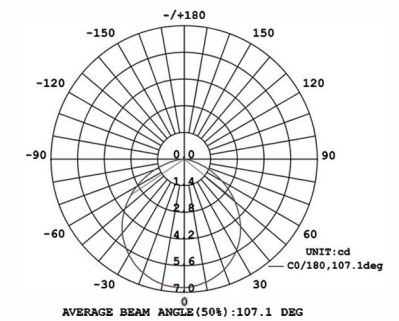
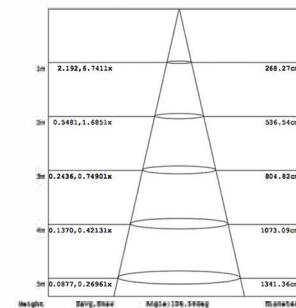

## LP118T GROUND LIGHT



TS118T

Optional accessories

### LED Colours



White 3000K White 4000K White 6000K RGB

### LP118T

Miniature recessed fixture complete with integral CREE LED package. Tempered glass, frosted optic serves to minimize glare coupled with a diffuse beam distribution. Marine Grade 316 Stainless Steel option with construction rated to IP68. Bronze option. Product footprint of 36mm diameter ensures versatile application.

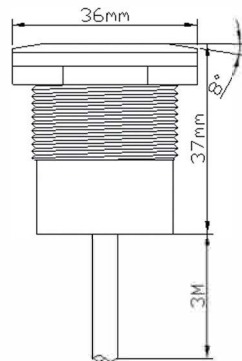

### DESCRIPTION

<b>LED Light source</b>	LED
<b>Light Color</b>	RGB,CW,WW,NW,Red,Green,Blue,Amber
<b>Material</b>	SUS316 / Brass
<b>Optics</b>	120°
<b>Power</b>	1W
<b>Power supply</b>	N/A
<b>Dimension</b>	D36X37
<b>Weight</b>	280g
<b>IP Rating</b>	IP68
<b>Approvals</b>	CE,RoHS,IP
<b>Ambient temperature</b>	-20°C ~ +45°C
<b>Average life</b>	50,000Hrs
<b>Accessories(Optional)</b>	
<b>Applications</b>	Indoor / Outdoor / Landscape / Submersible

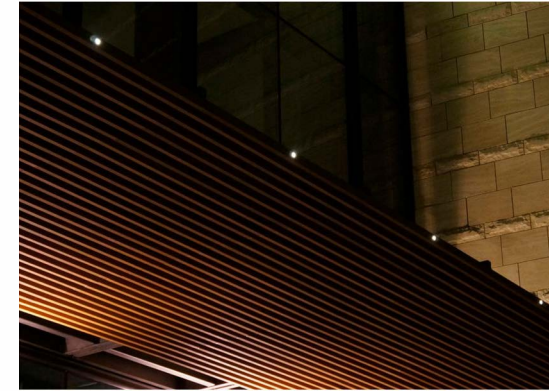

MODEL NO.	LED Brand	Color	BEAM	PowerMode	Input	Wiring	Cable	Power	Luminous Flux	Dimension	DrillSize	Material
LP 118T	OSRAM	CW,WW, NW,Red Green,Blue,Amber	120	Constant voltage	12/24VDC	Parallel	3M 2X0.75mm <sup>2</sup> Cable	1W	20LM	D36X37	D29	SUS316
LP 118TAB	OSRAM	CW,WW, NW,Red Green,Blue,Amber	120	Constant voltage	12/24VDC	Parallel	3M 2X0.75mm <sup>2</sup> Cable	1W	20LM	D36X37	D29	Brass
LP 118TRGB	Edison	RGB	120	Constant voltage	RGB24VDC	Parallel	1.1M 4X24AWG Cable	1W	N/A	D36X37	D29	SUS316
LP 118TABRGB	Edison	RGB	120	Constant voltage	RGB24VDC	Parallel	1.1M 4X24AWG Cable	1W	N/A	D36X37	D29	Brass

\*IES Data support.

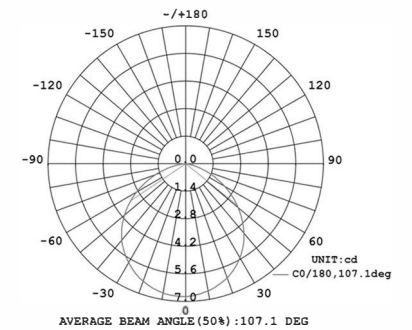
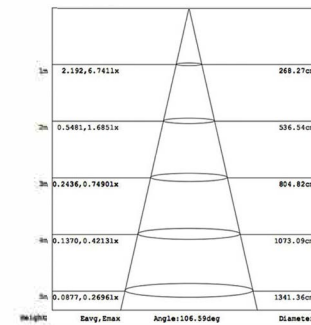



## LP119 GROUND LIGHT



TS119

Optional accessories

### LED Colours



White 3000K White 4000K White 6000K

### LP119

Miniature recessed fixture complete with integral CREE LED package. Tempered glass, marine grade 316 Stainless Steel option with construction rated to IP68. Product footprint of 40mm diameter ensures versatile application. Inline driver options include switched, 1-10V and DALI dimmable solutions.

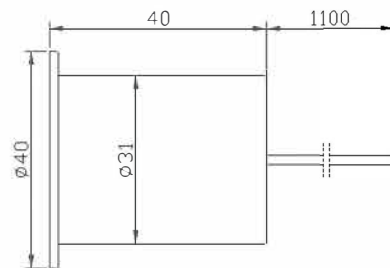

### DESCRIPTION

<b>LED Light source</b>	High Power LED
<b>Light Color</b>	CW, WW, NW, Red, Green, Blue, Amber
<b>Material</b>	SUS316
<b>Optics</b>	S20° / F60°
<b>Power</b>	1W
<b>Power supply</b>	N/A
<b>Dimension</b>	D40X40
<b>Weight</b>	140g
<b>IP Rating</b>	IP68
<b>Approvals</b>	CE, RoHS, IP
<b>Ambient temperature</b>	-20°C ~ +45°C
<b>Average life</b>	50,000Hrs
<b>Accessories(Optional)</b>	
<b>Applications</b>	Indoor/Outdoor/Landscape/Submersible

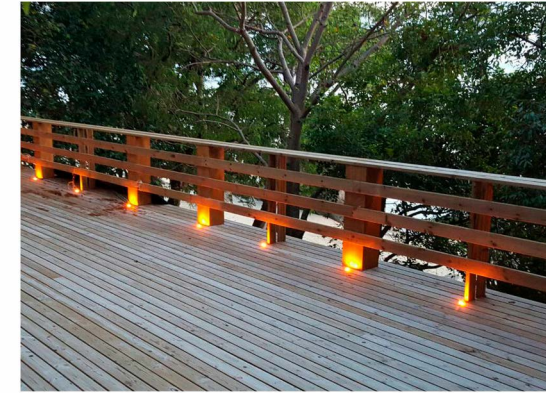

Model No.	LED Brand	Color	Beam	PowerMode	Input	Wiring	Cable	Power	Luminous Flux	Dimension	DrillSize
LP119	CREE	CW, WW, NW, Red, Green, Blue, Amber	S20/F60	Constant current	350mA	Series	1.1M 2X24AWG Cable	1W	100LM	D40X40	D33
LP119D	CREE	CW, WW, NW, Red, Green, Blue, Amber	S20/F60	Constant voltage	24VDC	Parallel	1.1M 2X24AWG Cable	1.3W	100LM	D40X40	D33

\*IES Data support.

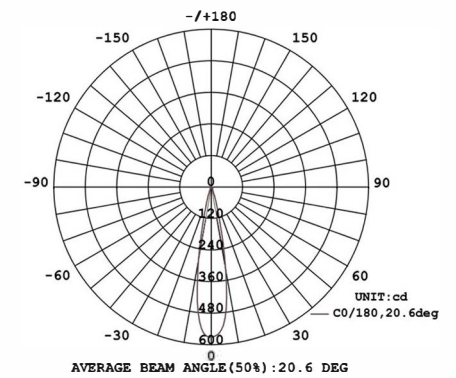
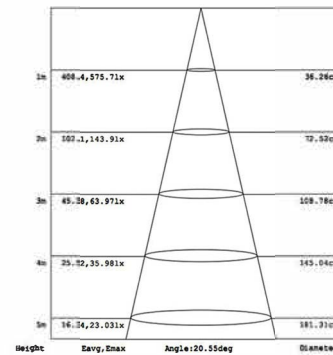

## LP119T GROUND LIGHT



### DESCRIPTION

<b>LED Light source</b>	High Power LED
<b>Light Color</b>	CW, WW, NW, Red, Green, Blue, Amber
<b>Material</b>	SUS316
<b>Optics</b>	S20° / F60°
<b>Power</b>	1W
<b>Power supply</b>	N/A
<b>Dimension</b>	D40X40
<b>Weight</b>	150g
<b>IP Rating</b>	IP68
<b>Approvals</b>	CE, RoHS, IP
<b>Ambient temperature</b>	-20°C ~ +45°C
<b>Average life</b>	50,000Hrs
<b>Accessories(Optional)</b>	N/A
<b>Applications</b>	Indoor / Outdoor / Landscape / Submersible



#### LED Colours



### LP 119T

Miniature recessed fixture complete with integral CREE LED package. Tempered glass, marine grade 316 Stainless Steel option with construction rated to IP68. Product footprint of 40mm diameter ensures versatile application. Inline driver options include switched, 1-10V and DALI dimmable solutions.

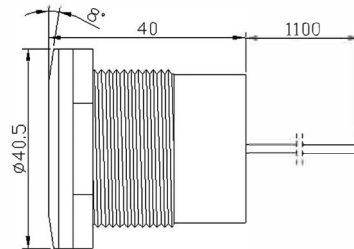

Model No.	LED Brand	Color	Beam	PowerMode	Input	Wiring	Cable	Power	Luminous Flux	Dimension	DrillSize
LP 119T	CREE	CW, WW, NW, Red, Green, Blue, Amber	S20/F60	Constant current	350mA	Series	1.1M 2X24AWG Cable	1W	100LM	D40X40	D33
LP119TD	CREE	CW, WW, NW, Red, Green, Blue, Amber	S20/F60	Constant voltage	24VDC	Parallel	1.1M 2X24AWG Cable	1.3W	100LM	D40X40	D33

\*IES Data support.

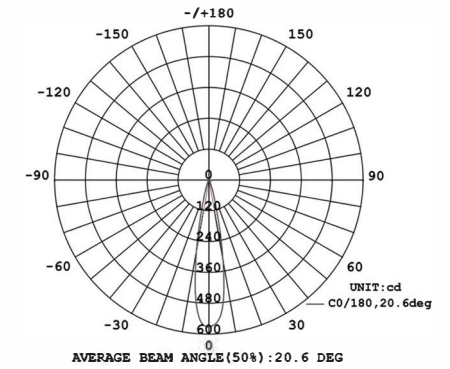
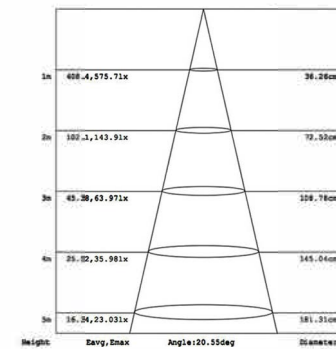

## LP 119CT GROUND LIGHT

### DESCRIPTION

<b>LED Light source</b>	High Power LED
<b>Light Color</b>	CW, WW, NW, Red, Green, Blue, Amber
<b>Material</b>	SUS316
<b>Optics</b>	S20° / F60°
<b>Power</b>	1W
<b>Power supply</b>	N/A
<b>Dimension</b>	D41.5X48
<b>Weight</b>	140g
<b>IP Rating</b>	IP68
<b>Approvals</b>	CE, RoHS, IP
<b>Ambient temperature</b>	-20°C ~ +45°C
<b>Average life</b>	50,000Hrs
<b>Accessories(Optional)</b>	N/A
<b>Applications</b>	Indoor / Outdoor / Landscape / Submersible

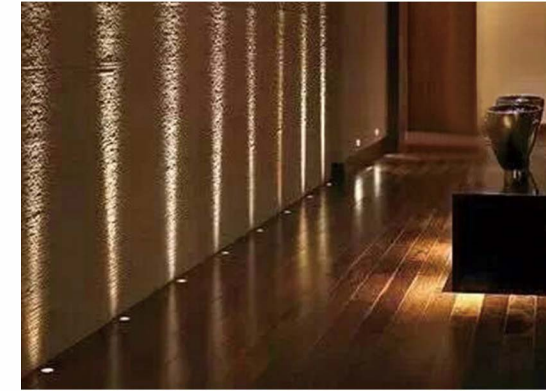

#### LED Colours



White 3000K    White 4000K    White 6000K

### LP 119CT

Miniature Eye-Lid fixture complete with integral CREE LED package and 20/60 degree beam options. Tempered glass, marine grade 316 Stainless Steel option with construction rated to IP68 with Eye-Lid design for asymmetric light emission. Product footprint of 41.5mm diameter ensures versatile application. Inline driver options include switched, 1-10V and DALI dimmable solutions.

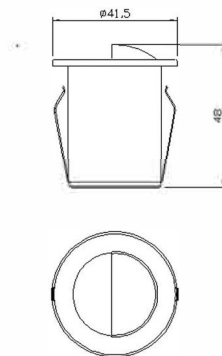

Model No.	LED Brand	Color	Beam	PowerMode	Input	Wiring	Cable	Power	Luminous Flux	Dimension	DrillSize
LP 119CT	CREE	CW, WW, NW, Red, Green, Blue, Amber	S20/F60	Constant current	350mA	Series	1.1M 2X24AWG Cable	1W	100LM	D41.5X48	D33
LP 119CTD	CREE	CW, WW, NW, Red, Green, Blue, Amber	S20/F60	Constant voltage	24VDC	Parallel	1.1M 2X24AWG Cable	1.3W	100LM	D41.5X48	D33

\*IES Data support.

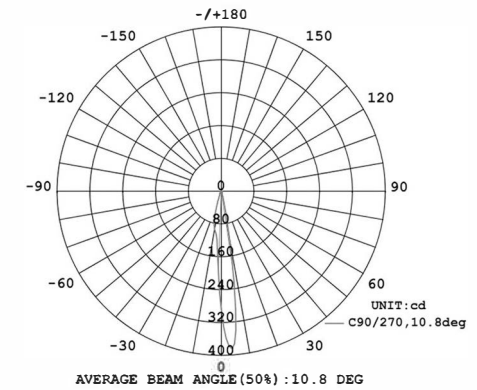
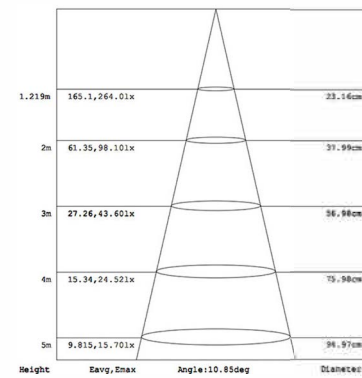



## LP119SQ GROUND LIGHT



TS119  
Optional accessories

### LED Colours



White 3000K White 4000K White 5000K

### LP119SQ

Square recessed fixture complete with integral CREE LED package and 20/60 degree beam options. Tempered glass, marine grade 316 Stainless Steel option with construction rated to IP68. Small Product footprint ensures versatile application. Inline driver options include switched, 1-10V and DALI dimmable solutions.

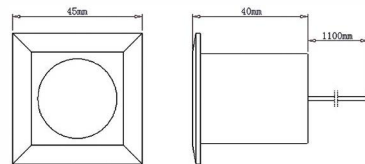

### DESCRIPTION

<b>LED Light source</b>	High Power LED
<b>Light Color</b>	CW, WW, NW, Red, Green, Blue, Amber
<b>Material</b>	SUS316
<b>Optics</b>	S20° / F60°
<b>Power</b>	1W
<b>Power supply</b>	N/A
<b>Dimension</b>	45X45X40
<b>Weight</b>	145g
<b>IP Rating</b>	IP68
<b>Approvals</b>	CE, RoHS, IP
<b>Ambient temperature</b>	-20°C ~ +45°C
<b>Average life</b>	50,000Hrs
<b>Accessories(Optional)</b>	
<b>Applications</b>	Indoor / Outdoor / Landscape / Submersible

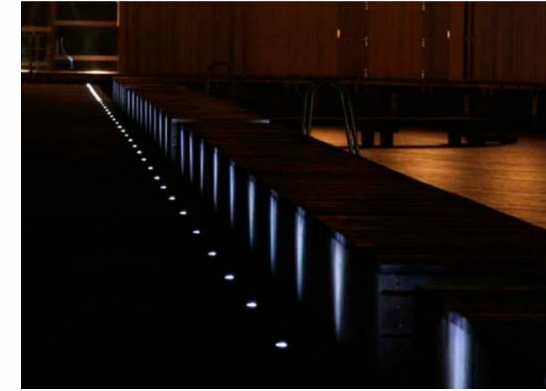

Model No.	LED Brand	Color	Beam	PowerMode	Input	Wiring	Cable	Power	Luminous Flux	Dimension	DrillSize
LP119SQ	CREE	CW, WW, NW, Red, Green, Blue, Amber	S20/F60	Constant current	350mA	Series	1.1M 2X24AWG Cable	1W	100LM	45X45X40	D33
LP119SQD	CREE	CW, WW, NW, Red, Green, Blue, Amber	S20/F60	Constant voltage	24VDC	Parallel	1.1M 2X24AWG Cable	1.3W	100LM	45X45X40	D33

\*IES Data support.

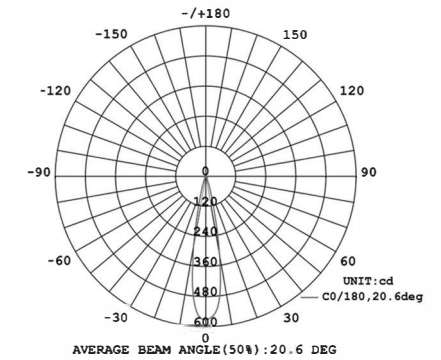
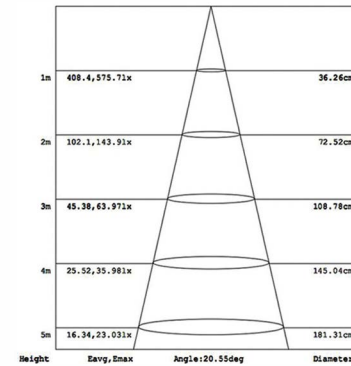

LP129 GROUND LIGHT

DESCRIPTION

<b>LED Light source</b>	High Power LED
<b>Light Color</b>	CW,WW,NW,Red,Green,Blue,Amber
<b>Material</b>	SUS316
<b>Optics</b>	S20° / F60°
<b>Power</b>	1W
<b>Power supply</b>	N/A
<b>Dimension</b>	D50X42
<b>Weight</b>	155g
<b>IP Rating</b>	IP68
<b>Approvals</b>	CE,RoHS,IP
<b>Ambient temperature</b>	-20°C ~ +45°C
<b>Average life</b>	50,000Hrs
<b>Accessories(Optional)</b>	
<b>Applications</b>	Indoor / Outdoor / Landscape / Submersible



LED Colours



White 3000K    White 4000K    White 6000K

LP129

Miniature recessed fixture complete with integral CREE LED package. Tempered glass, marine grade 316 Stainless Steel option with construction rated to IP68. Product footprint of 50mm diameter ensures versatile application. Inline driver options include switched, 1-10V and DALI dimmable solutions.

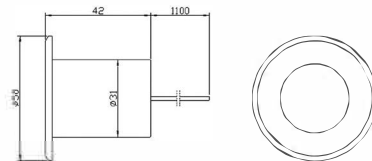

Model No.	LED Brand	Color	Beam	PowerMode	Input	Wiring	Cable	Power	Luminous Flux	Dimension	DrillSize
LP129	CREE	CW,WW, NW,Red Green,Blue,Amber	S20/F60	Constant current	350mA	Series	1.1M 2X24AWG Cable	1W	100LM	D50X42	D33
LP129D	CREE	CW,WW, NW,Red Green,Blue,Amber	S20/F60	Constant voltage	24VDC	Parallel	1.1M 2X24AWG Cable	1.3W	100LM	D50X42	D33

\*IES Data support.

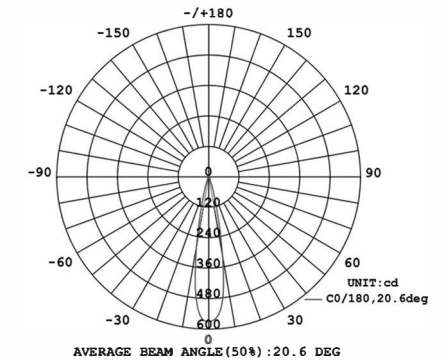
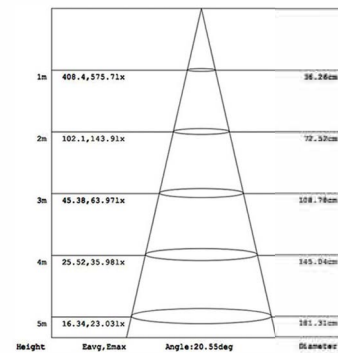

## LP108 GROUND LIGHT



### DESCRIPTION

<b>LED Light source</b>	High Power LED
<b>Light Color</b>	CW,WW,NW,Red,Green,Blue,Amber
<b>Material</b>	SUS316
<b>Optics</b>	120°
<b>Power</b>	1W
<b>Power supply</b>	N/A
<b>Dimension</b>	D45X12
<b>Weight</b>	70g
<b>IP Rating</b>	IP68
<b>Approvals</b>	CE,RoHS,IP
<b>Ambient temperature</b>	-20°C ~ +45°C
<b>Average life</b>	50,000Hrs
<b>Accessories(Optional)</b>	N/A
<b>Applications</b>	Indoor/Outdoor/Landscape/Submersible

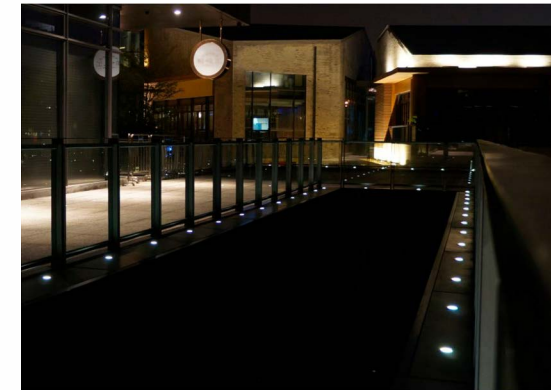

### LED Colours



### LP108

Marine Grade 316 Stainless Steel option with construction rated to IP68. Tempered glass with 120 degree beam option. It is designed to add style to floors, bars,walls and ceilings.The clever and stylish design of the light output means no glare even when looking directly at it, making this product perfect for stair facings. Installation will be quick and easy.

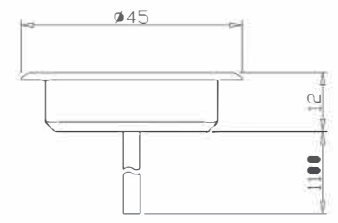

Model No.	LED Brand	Color	Beam	PowerMode	Input	Wiring	Cable	Power	Luminous Flux	Dimension	DrillSize
LP108	CREE	CW,WW, NW,Red,Green,Blue,Amber	120	Constant current	350mA	Series	1.1M 2X24AWG Cable	1W	75LM	D45X12	D38

\*IES Data support.

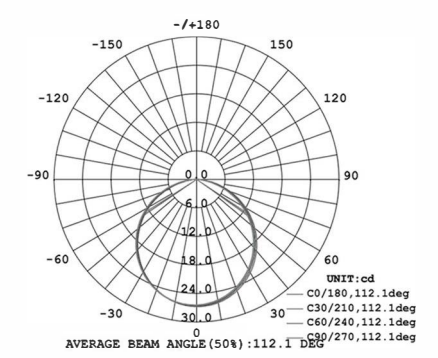
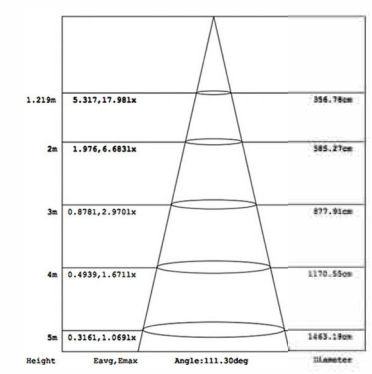



## LP308 GROUND LIGHT

### DESCRIPTION

<b>LED Light source</b>	LED
<b>Light Color</b>	RGB,CW,WW,NW,Red,Green,Blue,Amber
<b>Material</b>	SUS316
<b>Optics</b>	120°
<b>Power</b>	1W
<b>Power supply</b>	N/A
<b>Dimension</b>	D45X12
<b>Weight</b>	75g
<b>IP Rating</b>	IP68
<b>Approvals</b>	CE,RoHS,IP
<b>Ambient temperature</b>	-20°C ~ +45°C
<b>Average life</b>	50,000Hrs
<b>Accessories(Optional)</b>	N/A
<b>Applications</b>	Indoor/Outdoor/Landscape/Submersible



#### LED Colours



White 3000K   White 4000K   White 6000K   RGB

### LP308

Marine Grade 316 Stainless Steel option with construction rated to IP68. Tempered glass with 120 degree beam option. It is designed to add style to floors, bars, walls and ceilings. The clever and stylish design of the light output means no glare even when looking directly at it, making this product perfect for stair facings. Installation will be quick and easy.

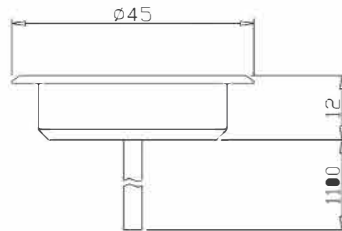

Model No.	LED Brand	Color	Beam	PowerMode	Input	Wiring	Cable	Power	Luminous Flux	Dimension	DrillSize
LP308	OSRAM	CW,WW, NW,Red,Green,Blue,Amber	120	Constant voltage	12/24VDC	Parallel	1.1M 2X24AWG Cable	1W	20LM	D45X12	D38
LP308RGB	EDISON	RGB	120	Constant voltage	24VDC	Parallel	1.1M 4X24AWG Cable	1W	N/A	D45X12	D38

\*IES Data support.

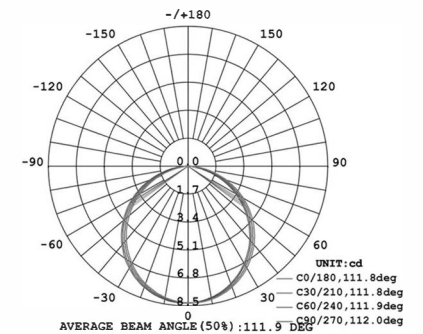
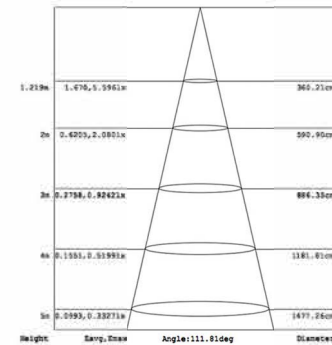

LP117 GROUND LIGHT



GL117AL

LP117-1W

LED Colours



White 3000K White 4000K White 6000K

LP117

Tempered glass, marine grade 316 stainless steel bezel panel with aluminum lamp body. Integral CREE LED package. Product footprint of 60mm diameter ensures versatile application. 120 degree beam as standard, product functions with 350mA constant current driver. Inline driver options include switched, 1-10V and DALI dimmable solutions.

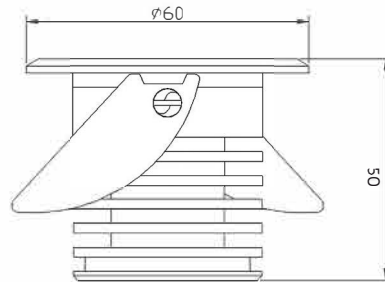

DESCRIPTION

<b>LED Light source</b>	High Power LED
<b>Light Color</b>	CW,WW,NW,Red,Green,Blue,Amber
<b>Material</b>	SUS316(Lamp cap)+Aluminium(Lamp cup)
<b>Optics</b>	10° / S20° / 45° / F60°
<b>Power</b>	3W
<b>Power supply</b>	N/A
<b>Dimension</b>	D60X50
<b>Weight</b>	N/A
<b>IP Rating</b>	IP67
<b>Approvals</b>	CE,RoHS,IP
<b>Ambient temperature</b>	-20°C ~ +45°C
<b>Average life</b>	50,000Hrs
<b>Accessories(Optional)</b>	N/A
<b>Applications</b>	Indoor/Outdoor



Model No.	LED Brand	Color	Beam	PowerMode	Input	Wiring	Cable	Power	Luminous Flux	Dimension	DrillSize
LP117	CREE	CW,WW, NW,Red Green,Blue,Amber	10/S20/45/F60	Constant current	350mA	Series	1.1M 2X24AWG Cable	3W	220LM	D60X50	D50
LP117D	CREE	CW,WW, NW,Red Green,Blue,Amber	10/S20/45/F60	Constant voltage	24VDC	Parallel	1.1M 2X24AWG Cable	3.5W	220LM	D60X50	D50
LP117DMX	CREE	CW,WW, NW,Red Green,Blue,Amber	10/S20/45/F60	Constant voltage	DMX24VDC	Parallel	1.1M 5X0.5mm <sup>2</sup> Cable	3.5W	220LM	D60X50	D50

DMX decoder in built

\*IES Data support.

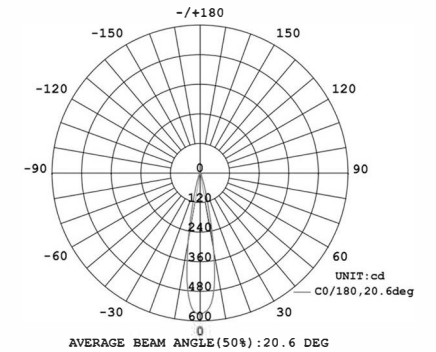
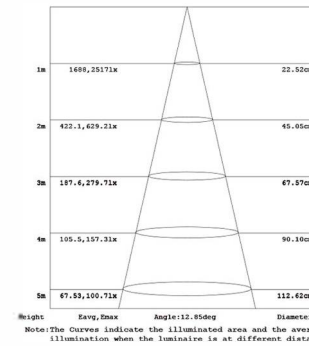

LP130 GROUND LIGHT



Optional accessories

LED Colours

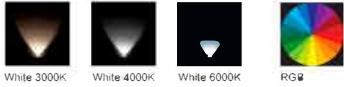

White 3000K White 4000K White 6000K RGB

LP130

Tempered glass, marine grade 316 stainless steel bezel panel with aluminum lamp body. Hidden & embedded design installation. This fixture complete with integral CREE LED package. Fixture rated to IP67.

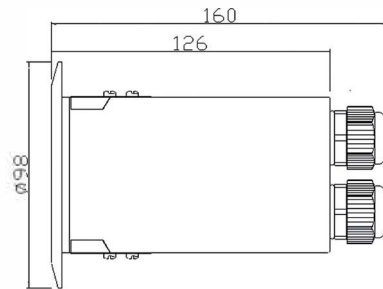

DESCRIPTION

<b>LED Light source</b>	High Power LED
<b>Light Color</b>	CW,WW,NW,Red,Green,Blue,Amber
<b>Material</b>	SUS316(Lamp cap)+Aluminum(Lamp cup)
<b>Optics</b>	S20° / F60°
<b>Power</b>	3W
<b>Power supply</b>	N/A
<b>Dimension</b>	D98X160
<b>Weight</b>	930g
<b>IP Rating</b>	IP67
<b>Approvals</b>	CE,RoHS,IP
<b>Ambient temperature</b>	-20°C ~ +45°C
<b>Average life</b>	50,000Hrs
<b>Accessories(Optional)</b>	
<b>Applications</b>	Indoor/Outdoor/Landscape

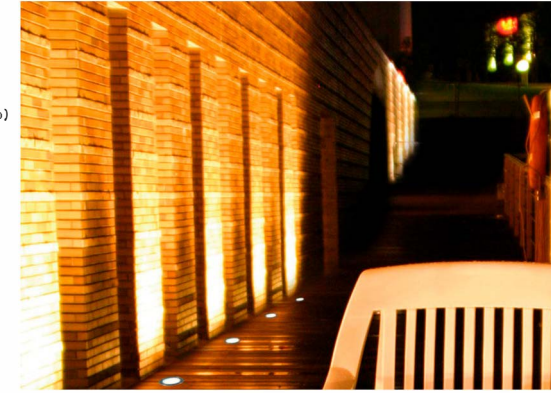

Model No.	LED Brand	Color	Beam	PowerMode	Input	Wiring	Cable	Power	Luminous Flux	Dimension	DrillSize
LP130	CREE	CW,WW, NW,Red Green,Blue,Amber	S20/F60	Constant voltage	100-240VAC	Parallel	N/A	3W	250LM	D98X160	D74
LP130D	CREE	CW,WW, NW,Red Green,Blue,Amber	S20/F60	Constant voltage	24VDC	Parallel	N/A	3W	250LM	D98X160	D74
LP130RGB	CREE	RGB	45	Constant current	350mA	Series	N/A	3W	N/A	D98X160	D74

\*IES Data support.

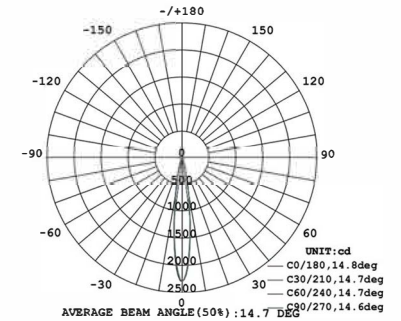
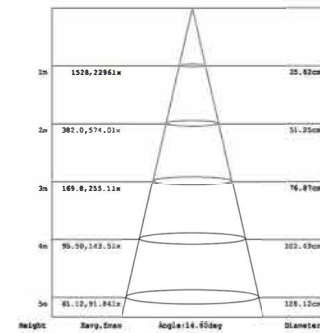



## LP140 GROUND LIGHT



TS140  
Optional accessories

### LED Colours



White 3000K White 4000K White 6000K RGB

### LP140

Miniature recessed fixture complete with integral CREE LED package and 20/60 degree beam options. Tempered glass, marine grade 316 Stainless Steel option with construction rated to IP68. Product footprint of 76mm diameter ensures versatile application. Inline driver options include switched, 1-10V and DALI dimmable solutions.

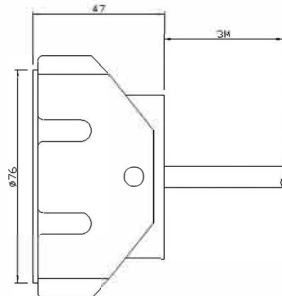

### DESCRIPTION

<b>LED Light source</b>	High Power LED
<b>Light Color</b>	RGB,CW,WW,NW,Red,Green,Blue,Amber
<b>Material</b>	SUS316 / Brass
<b>Optics</b>	S20° / F60°
<b>Power</b>	3W
<b>Power supply</b>	N/A
<b>Dimension</b>	D76X47
<b>Weight</b>	N/A
<b>IP Rating</b>	IP68
<b>Approvals</b>	CE,RoHS,IP
<b>Ambient temperature</b>	-20°C ~ +45°C
<b>Average life</b>	50,000Hrs
<b>Accessories(Optional)</b>	
<b>Applications</b>	Indoor/Outdoor/Landscape/Submersible



Model No.	LED Brand	Color	Beam	PowerMode	Input	Wiring	Cable	Power	Luminous Flux	Dimension	DrillSize
LP140	CREE	CW,WW, NW,Red Green,Blue,Amber	10/S20/30 /45/F60	Constant current	350mA	Series	3M 2X0.75mm <sup>2</sup> Cable	3W	300LM	D76X47	D65
LP140D	CREE	CW,WW, NW,Red Green,Blue,Amber	10/S20/30 /45/F60	Constant voltage	12/24VDC	Parallel	3M 2X0.75mm <sup>2</sup> Cable	3.5W	300LM	D76X47	D65
LP140RGB	CREE	R+G+B	10/S20/30 /45/F60	Constant current	350mA	Series	2x3M 4X0.5mm <sup>2</sup> Cable	3W	N/A	D76X47	D65
LP140RGB-9W(IP67)	Edison	RGB	45	Constant current	350mA Controller	Series	2x3M 4X0.5mm <sup>2</sup> Cable	9W	N/A	D76X86	D65
LP140DMX-RGB	Edison	RGB(FullColor)	10/S20/30 /45/F60	Constant voltage	24VDC DMX Controller	Parallel	1.1M 4X0.5mm <sup>2</sup> Cable	3.5W	N/A	D76X47	D65
LP140DMX-RGBW	Edison	RGBW(FullColor)	10/S20/30 /45/F60	Constant voltage	24VDC DMX Controller	Parallel	1.1M 4X0.5mm <sup>2</sup> Cable	3.5W	N/A	D76X47	D65

DMX decoder in built

\*IES Data support.

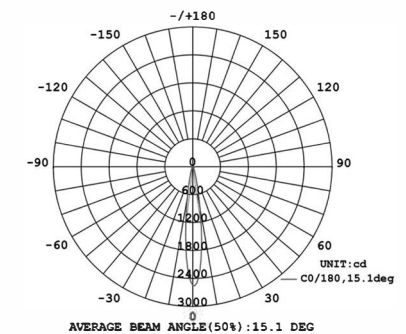
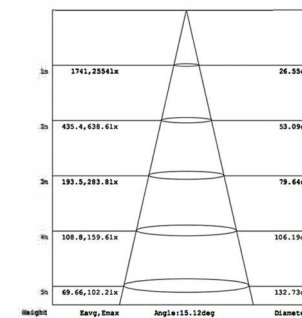

## LP140SQ GROUND LIGHT

### DESCRIPTION

<b>LED Light source</b>	High Power LED
<b>Light Color</b>	RGB,CW,WW,NW,Red,Green,Blue,Amber
<b>Material</b>	SUS316
<b>Optics</b>	S20° / F60°
<b>Power</b>	3W
<b>Power supply</b>	N/A
<b>Dimension</b>	76X76X47
<b>Weight</b>	N/A
<b>IP Rating</b>	IP68
<b>Approvals</b>	CE,RoHS,IP
<b>Ambient temperature</b>	-20°C ~ +45°C
<b>Average life</b>	50,000Hrs
<b>Accessories(Optional)</b>	
<b>Applications</b>	Indoor/Outdoor/Landscape/Submersible

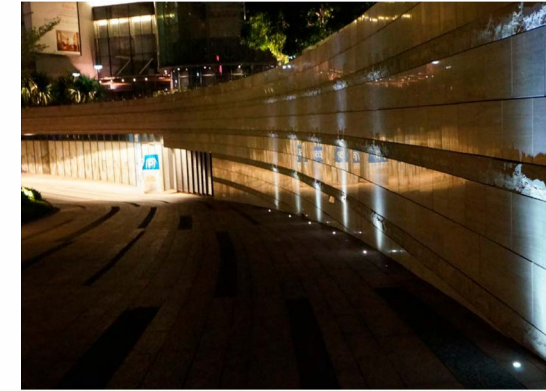

Optional accessories

#### LED Colours



White 3000K White 4000K White 6000K RGB

### LP140SQ

Square recessed fixture complete with integral CREE LED package and 20/60 degree beam options. Tempered glass, marine grade 316 Stainless Steel option with construction rated to IP68. Product footprint of 76mm diameter ensures versatile application. Inline driver options include switched, 1-10V and DALI dimmable solutions.

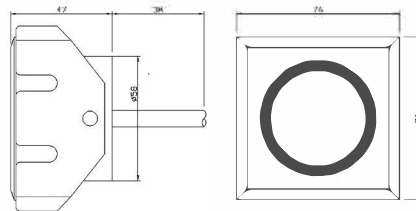

Model No.	LED Brand	Color	Beam	PowerMode	Input	Wiring	Cable	Power	Luminous Flux	Dimension	DrillSize
LP140SQ	CREE	CW,WW, NW,Red Green,Blue,Amber	S20/F60	Constant current	350mA	Series	3M 2X0.75mm <sup>2</sup> Cable	3W	300LM	76X76X47	D65
GL140SQD	CREE	CW,WW, NW,Red Green,Blue,Amber	S20/F60	Constant voltage	12/24VDC	Parallel	3M 2X0.75mm <sup>2</sup> Cable	3.5W	300LM	76X76X47	D65
LP140SQRGB	CREE	R+G+B	S20/F60	Constant current	350mA	Series	2x3M 4X0.5mm <sup>2</sup> Cable	3W	N/A	76X76X47	D65
LP140SQ-DMX-RGB	Edison	RGB(FullColor)	S20/F60	Constant voltage	24VDC DMX Controller	Parallel	1.1M 4X0.5mm <sup>2</sup> Cable	3.5W	N/A	76X76X47	D65

DMX decoder is built

\*IES Data support.

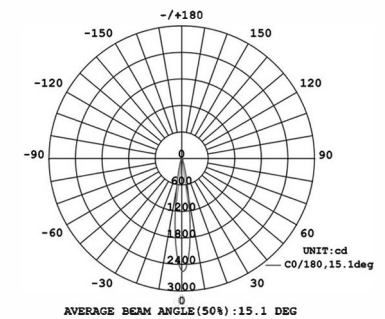
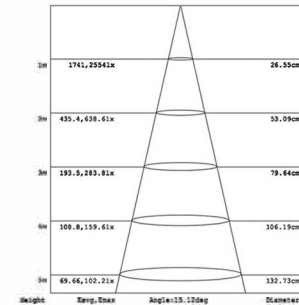

## LP150 GROUND LIGHT



GL150SQ



Optional accessories

### LED Colours



White 3000K White 4000K White 6000K RGB

### LP150

Miniature recessed fixture complete with integral CREE LED package and 120 degree beam option. Tempered glass, marine grade 316 Stainless Steel construction rated to IP68. Product footprint of 76mm diameter ensures versatile application. Inline driver options include switched, 1-10V and DALI dimmable solutions.

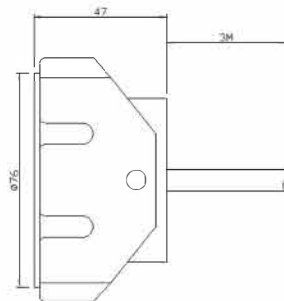

### DESCRIPTION

<b>LED Light source</b>	High Power LED
<b>Light Color</b>	RGB,CW,WW,NW,Red,Green,Blue,Amber
<b>Material</b>	SUS316
<b>Optics</b>	120°
<b>Power</b>	3W
<b>Power supply</b>	N/A
<b>Dimension</b>	D76X47
<b>Weight</b>	635g
<b>IP Rating</b>	IP68
<b>Approvals</b>	CE,RoHS,IP
<b>Ambient temperature</b>	-20°C ~ +45°C
<b>Average life</b>	50,000Hrs
<b>Accessories(Optional)</b>	
<b>Applications</b>	Indoor/Outdoor/Landscape/Submersible



Model No.	LED Brand	Color	Beam	PowerMode	Input	Wiring	Cable	Power	Luminous Flux	Dimension	DrillSize
LP150	CREE	CW,WW, NW,Red,Green,Blue,Amber	120	Constant current	350mA	Series	3M 2X0.75mm <sup>2</sup> Cable	3W	300LM	D76X47	D65
LP150D	CREE	CW,WW, NW,Red,Green,Blue,Amber	120	Constant voltage	12/24VDC	Parallel	3M 2X0.75mm <sup>2</sup> Cable	3.5W	300LM	D76X47	D65
LP150SQ	CREE	CW,WW, NW,Red,Green,Blue,Amber	120	Constant current	350mA	Series	3M 2X0.75mm <sup>2</sup> Cable	3W	300LM	76X76X47	D65
LP150RGB	EDISON	RGB	120	Constant current	350mA	Series	2x3M 4X0.5mm <sup>2</sup> Cable	7W	N/A	D76X47	D65
LP 150DMX-RGB	EDISON	RGB	120	Constant voltage	24VDC DMX Controller	Parallel	1.1M 4X0.5mm <sup>2</sup> Cable	3.5W	N/A	D76X47	D65

DMX decoder in built

\*IES Data support.

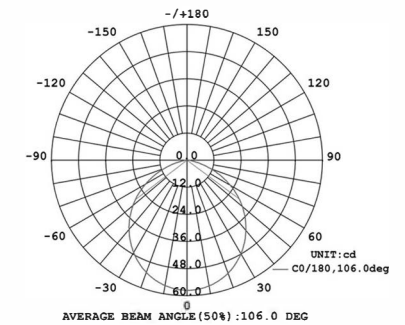
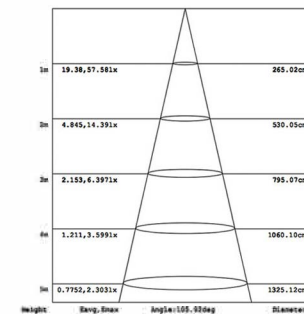



## LP550RGB GROUND LIGHT



### LED Colours



### LP550RGB

Miniature recessed fixture complete with integral Edison LED package and 120 degree beam option. Marine Grade 316 Stainless Steel construction rated to IP68. Tempered glass. Product footprint of 76mm diameter ensures versatile application.

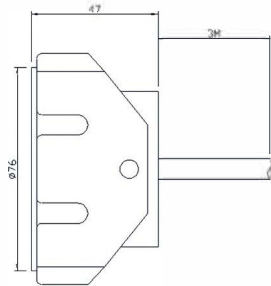

### DESCRIPTION

<b>LED Light source</b>	High Power LED
<b>Light Color</b>	RGB,CW,WW,NW,Red,Green,Blue,Amber
<b>Material</b>	SUS316
<b>Optics</b>	120°
<b>Power</b>	3W
<b>Power supply</b>	N/A
<b>Dimension</b>	D76X47
<b>Weight</b>	680g
<b>IP Rating</b>	IP68
<b>Approvals</b>	CE,RoHS,IP
<b>Ambient temperature</b>	-20°C ~ +45°C
<b>Average life</b>	50,000Hrs
<b>Accessories(Optional)</b>	
<b>Applications</b>	Indoor/Outdoor/Landscape/Submersible

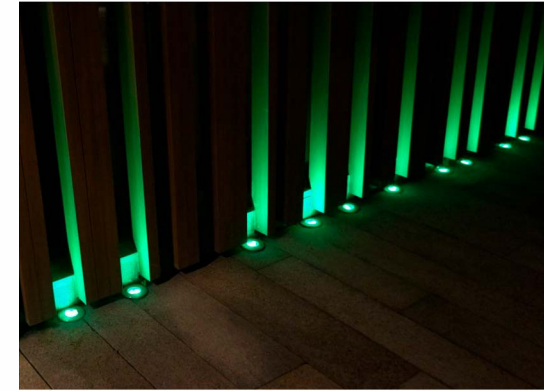

Model No.	LED Brand	Color	Beam	PowerMode	Input	Wiring	Cable	Power	Luminous Flux	Dimension	DrillSize
LP550RGB	CREE	RGB	120	Constant voltage	24VDC	Parallel	3M 4X0.5mm <sup>2</sup> Cable	3W	N/A	D76X47	D65
LP550DMX-RGB	CREE	RGB	120	Constant voltage	24VDC DMX Controller	Parallel	1.1M 4X0.5mm <sup>2</sup> Cable	3W	N/A	D76X47	D65

DMX decoder in built

\*IES Data support.

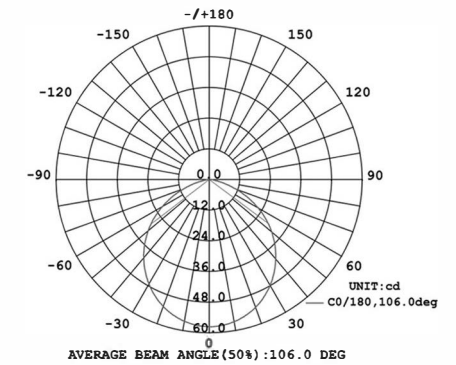
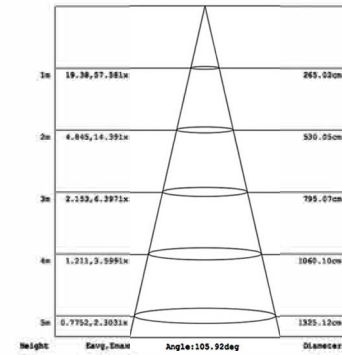

## LP151 GROUND LIGHT



Optional accessories

### LED Colours

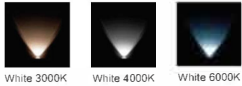

White 3000K White 4000K White 6000K

### LP151

Marine grade 316 stainless steel in-ground single marker light complete with integral CREE LED package. Tempered glass, fixture rated to IP68 with single aperture for asymmetric emission. 120 degree beam as standard, product functions with 350mA constant current driver. Inline driver options include switched, 1-1 0V and DALI dimmable solutions.

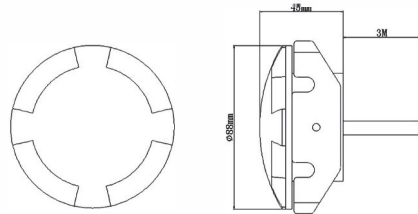

### DESCRIPTION

<b>LED Light source</b>	High Power LED
<b>Light Color</b>	CW, WW, NW, Red, Green, Blue, Amber
<b>Material</b>	SUS316
<b>Optics</b>	N/A
<b>Power</b>	3W
<b>Power supply</b>	N/A
<b>Dimension</b>	D88X45
<b>Weight</b>	N/A
<b>IP Rating</b>	IP68
<b>Approvals</b>	CE, RoHS, IP
<b>Ambient temperature</b>	-20°C ~ +45°C
<b>Average life</b>	50,000Hrs
<b>Accessories(Optional)</b>	
<b>Applications</b>	Indoor / Outdoor / Landscape / Submersible



Model No.	LED Brand	Color	Beam	PowerMode	Input	Wiring	Cable	Power	Luminous Flux	Dimension	DrillSize
LP151	CREE	CW, WW, NW, Red Green, Blue, Amber	N/A	Constant current	350mA	Series	3M 2X0.75mm <sup>2</sup> Cable	3W	N/A	D88X45	D65
LP152	CREE	CW, WW, NW, Red Green, Blue, Amber	N/A	Constant current	350mA	Series	3M 2X0.75mm <sup>2</sup> Cable	3W	N/A	D88X45	D65
LP154	CREE	CW, WW, NW, Red Green, Blue, Amber	N/A	Constant current	350mA	Series	3M 2X0.75mm <sup>2</sup> Cable	3W	N/A	D88X45	D65
LP151D	CREE	CW, WW, NW, Red Green, Blue, Amber	N/A	Constant voltage	12/24VDC	Parallel	3M 2X0.75mm <sup>2</sup> Cable	3.5W	N/A	D88X45	D65
LP152D	CREE	CW, WW, NW, Red Green, Blue, Amber	N/A	Constant voltage	12/24VDC	Parallel	3M 2X0.75mm <sup>2</sup> Cable	3.5W	N/A	D88X45	D65
LP154D	CREE	CW, WW, NW, Red Green, Blue, Amber	N/A	Constant voltage	12/24VDC	Parallel	3M 2X0.75mm <sup>2</sup> Cable	3.5W	N/A	D88X45	D65

\*IES Data support.

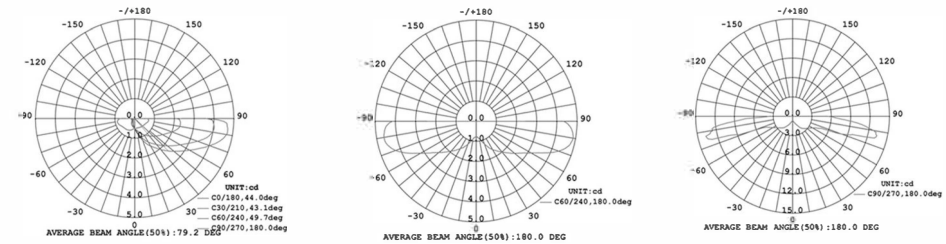

## LP166 GROUND LIGHT



### LED Colours



White 3000K   White 4000K   White 6000K   RGB

### LP166

Midsized surface fixture complete with integral CREE XPE LED (6pcs LED) package and 10/40 degree beam options. Tempered glass, marine Grade 316 Stainless Steel construction rated to IP68. Hidden & embedded design installation. No mechanical joints to light source ensures robust protection against water ingress. Product runs cool meeting all touch temperature requirements. In-line 350mA driver options include switched, mains, 1-10V and DALI dimmable solutions.

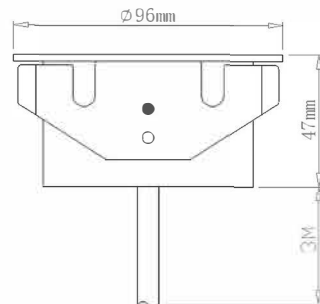

### DESCRIPTION

<b>LED Light source</b>	High Power LED
<b>Light Color</b>	RGB,CW,WW,NW,Red,Green,Blue,Amber
<b>Material</b>	SUS316
<b>Optics</b>	S10° / F40°
<b>Power</b>	6W
<b>Power supply</b>	N/A
<b>Dimension</b>	D96X47
<b>Weight</b>	940g
<b>IP Rating</b>	IP68
<b>Approvals</b>	CE,RoHS,IP
<b>Ambient temperature</b>	-20°C ~ +45°C
<b>Average life</b>	50,000Hrs
<b>Accessories(Optional)</b>	N/A
<b>Applications</b>	Indoor / Outdoor / Landscape / Submersible



Model No.	LED Brand	Color	Beam	PowerMode	Input	Wiring	Cable	Power	Luminous Flux	Dimension	DrillSize
LP166	CREE	CW,WW, NW,Red Green,Blue,Amber	S10/F40	Constant current	350mA	Series	3M 2X0.75mm <sup>2</sup> Cable	6W	600LM	D96X47	D85
LP166D	CREE	CW,WW, NW,Red Green,Blue,Amber	S10/F40	Constant voltage	24VDC	Parallel	3M 2X0.75mm <sup>2</sup> Cable	6.5W	600LM	D96X47	D85
LP166RGB	CREE	2R+2G+2B	S10/F40	Constant current	350mA	Series	2x3M 4X0.5mm <sup>2</sup> Cable	6W	N/A	D96X47	D85
LP 166DMX-RGB	CREE	2R+2G+2B	S10/F40	Constant voltage	24VDC DMX Controller	Parallel	1.1M 4X0.5mm <sup>2</sup> Cable	6.5W	N/A	D96X47	D85
LP 166DMX-RGB	Edison	RGB(Fullcolor)	S10/F40	Constant voltage	24VDC DMX Controller	Parallel	1.1M 4X0.5mm <sup>2</sup> Cable	6.5W	N/A	D96X47	D85
LP 166DMX-RGBW	Edison	RGBW(Fullcolor)	S10/F40	Constant voltage	24VDC DMX Controller	Parallel	1.1M 4X0.5mm <sup>2</sup> Cable	6.5W	N/A	D96X47	D85

DMX decoder in built

\*IES Data support.

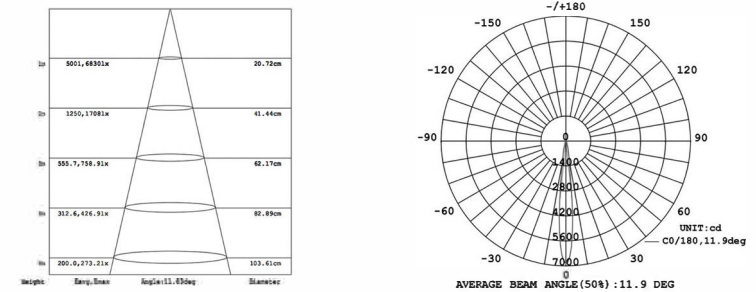



## LP168 GROUND LIGHT



### LED Colours



### LP168

Midsize surface fixture complete with integral CREE XPE LED (8pcs LED) package and 10/40 degree beam options. Tempered glass, marine grade 316 Stainless Steel construction rated to IP68. Hidden & embedded design installation. No mechanical joints to light source ensures robust protection against water ingress. Product runs cool meeting all touch temperature requirements. Inline 350mA driver options include switched, mains, 1-10V and DALI dimmable solutions.

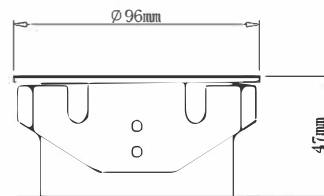

### DESCRIPTION

<b>LED Light source</b>	High Power LED
<b>Light Color</b>	RGB,CW,WW,NW,Red,Green,Blue,Amber
<b>Material</b>	SUS316
<b>Optics</b>	S10° / F40°
<b>Power</b>	8W
<b>Power supply</b>	N/A
<b>Dimension</b>	D96X47
<b>Weight</b>	940g
<b>IP Rating</b>	IP68
<b>Approvals</b>	CE,RoHS,IP
<b>Ambient temperature</b>	-20°C ~ +45°C
<b>Average life</b>	50,000Hrs
<b>Accessories(Optional)</b>	N/A
<b>Applications</b>	Indoor / Outdoor / Landscape / Submersible



Model No.	LED Brand	Color	Beam	PowerMode	Input	Wiring	Cable	Power	Luminous Flux	Dimension	DrillSize
LP168	CREE	CW,WW, NW,Red Green,Blue,Amber	S10/F40	Constant current	350mA	Series	3M 2X0.75mm <sup>2</sup> Cable	8W	800LM	D96X47	D85
LP 168D	CREE	CW,WW, NW,Red Green,Blue,Amber	S10/F40	Constant voltage	24VDC	Parallel	3M 2X0.75mm <sup>2</sup> Cable	9W	800LM	D96X47	D85
LP168RGB	CREE	3R+3G+2B	S10/F40	Constant current	350mA	Series	2x3M 4X0.5mm <sup>2</sup> Cable	8W	N/A	D96X47	D85
LP 168DMX-RGB	CREE	3R+3G+2B	S10/F40	Constant voltage	24VDC DMX Controller	Parallel	1.1M 4X0.5mm <sup>2</sup> Cable	9W	N/A	D96X47	D85

DMX decoder in built

\*IES Data support.

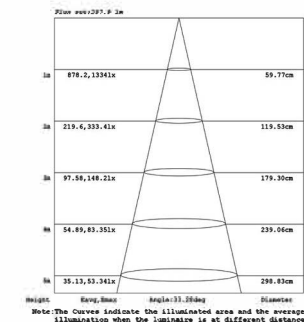
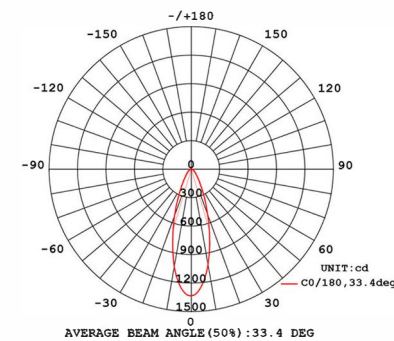

## LP191 GROUND LIGHT



### LED Colours



White 3000K    White 4000K    White 6000K

### LP191

Marine grade 316 stainless steel in-ground light complete with integral CREE LED package. Tempered glass, fixture rated to IP68 allowing submersion in water thus negating common issues arising from lack of soil drainage. Product functions with 350mA constant current driver. No mechanical joints to light source ensures robust protection against water ingress. Product runs cool meeting all "touch temperature" requirements.

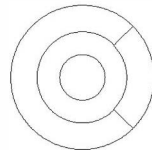
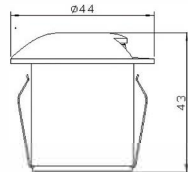

### DESCRIPTION

<b>LED LIGHT SOURCE</b>	High Power LED
<b>LIGHT COLOR</b>	CW, WW, NW, Red, Green, Blue, Amber
<b>MATERIAL</b>	SUS316
<b>OPTICS</b>	N/A
<b>POWER</b>	1W
<b>POWER SUPPLY</b>	N/A
<b>DIMENSION</b>	D44X43
<b>WEIGHT</b>	140g
<b>IP RATING</b>	IP68
<b>APPROVALS</b>	CE, RoHS, IP
<b>AMBIENT TEMPERATURE</b>	-20°C ~ +45°C
<b>AVERAGE LIFE</b>	50,000Hrs
<b>ACCESSORIES(OPTIONAL)</b>	N/A
<b>APPLICATIONS</b>	Indoor / Outdoor / Landscape

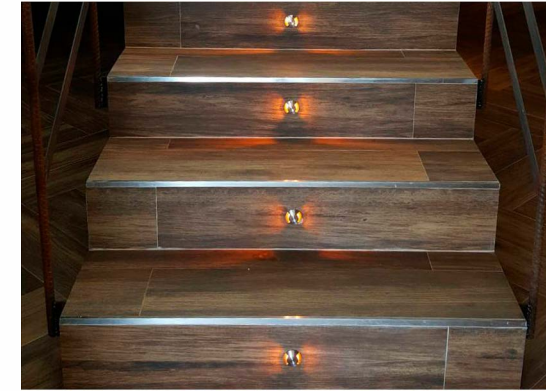

Model No.	LED Brand	Color	Beam	PowerMode	Input	Wiring	Cable	Power	Luminous Flux	Dimension	DrillSize
LP191	CREE	CW, WW, NW, Red, Green, Blue, Amber	N/A	Constant current	350mA	Series	1.1M 2X24AWG Cable	1W	N/A	D44X43	D32
LP192	CREE	CW, WW, NW, Red, Green, Blue, Amber	N/A	Constant current	350mA	Series	1.1M 2X24AWG Cable	1W	N/A	D44X43	D32
LP193	CREE	CW, WW, NW, Red, Green, Blue, Amber	N/A	Constant current	350mA	Series	1.1M 2X24AWG Cable	1W	N/A	D44X43	D32
LP 191D	CREE	CW, WW, NW, Red, Green, Blue, Amber	N/A	Constant voltage	24VDC	Parallel	1.1M 2X24AWG Cable	1.3W	N/A	D44X43	D32
LP 192D	CREE	CW, WW, NW, Red, Green, Blue, Amber	N/A	Constant voltage	24VDC	Parallel	1.1M 2X24AWG Cable	1.3W	N/A	D44X43	D32
LP 193D	CREE	CW, WW, NW, Red, Green, Blue, Amber	N/A	Constant voltage	24VDC	Parallel	1.1M 2X24AWG Cable	1.3W	N/A	D44X43	D32

\*IES Data support.

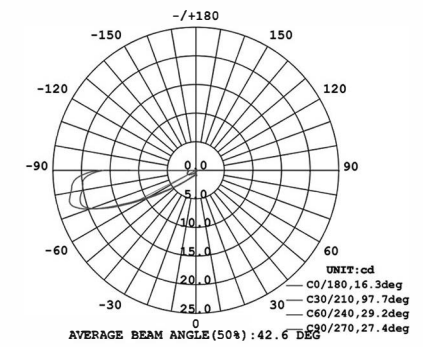
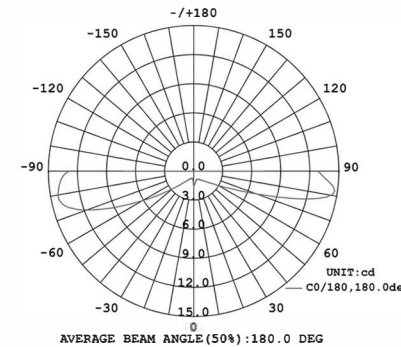

## LP266 GROUND LIGHT

### DESCRIPTION

<b>LED Light source</b>	High Power LED
<b>Light Color</b>	RGB,CW,WW,NW,Red,Green,Blue,Amber
<b>Material</b>	SUS316
<b>Optics</b>	S10° / F40°
<b>Power</b>	6W
<b>Power supply</b>	N/A
<b>Dimension</b>	D96X47
<b>Weight</b>	940g
<b>IP Rating</b>	IP67
<b>Approvals</b>	CE,RoHS,IP
<b>Ambient temperature</b>	-20°C ~ +45°C
<b>Average life</b>	50,000Hrs
<b>Accessories(Optional)</b>	N/A
<b>Applications</b>	Indoor / Outdoor / Landscape / Submersible



Model No.	LED Brand	Color	Beam	PowerMode	Input	Wiring	Cable	Power	Luminous Flux	Dimension	DrillSize
LP266	CREE	CW,WW, NW,Red Green,Blue,Amber	S10/F40	Constant current	350mA	Series	3M 2X0.75mm <sup>2</sup> Cable	6W	600LM	D96X47	N/A
LP266D	CREE	CW,WW, NW,Red Green,Blue,Amber	S10/F40	Constant voltage	24VDC	Parallel	3M 2X0.75mm <sup>2</sup> Cable	6.5W	600LM	D96X47	N/A
LP266RGB	CREE	RGB(2R+2G+2B)	S10/F40	Constant current	350mA	Series	2x3M 4X0.5mm <sup>2</sup> Cable	6W	N/A	D96X47	N/A

### LED Colours



White 3000K    White 4000K    White 6000K    RGB

### LP266

Midsize surface fixture complete with integral CREE XPE LED (6pcs LED) package and 10/40 degree beam options. Tempered glass, marine grade 316 Stainless Steel construction rated to IP68. No mechanical joints to light source ensures robust protection against water ingress. Product runs cool meeting all touch temperature requirements. In-line 350mA driver options include switched, mains, 1-10V and DALI dimmable solutions.

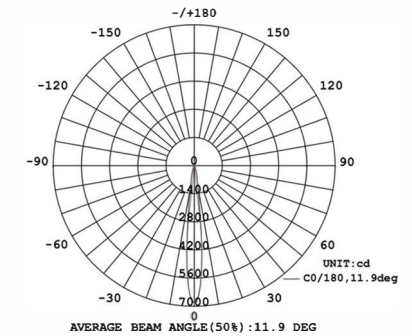
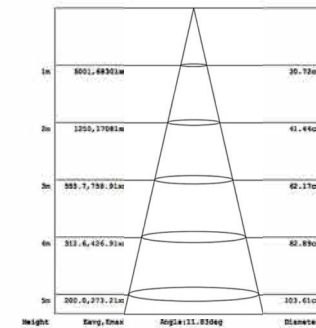
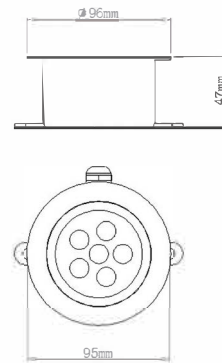

\*IES Data support.





## LP268 GROUND LIGHT



### LED Colours



White 3000K White 4000K White 6000K RGB

### LP268

Midsize surface fixture complete with integral CREE XPE LED (8pcs LED) package and 10/40 degree beam options. Tempered glass, marine grade 316 Stainless Steel construction rated to IP68. No mechanical joints to light source ensures robust protection against water ingress. Product runs cool meeting all touch temperature requirements. Inline 350mA driver options include switched, mains, 1-10V and DALI dimmable solutions.

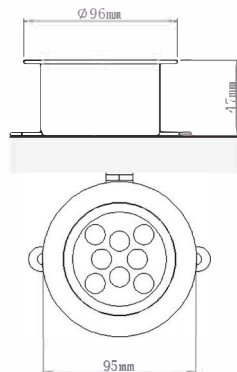

### DESCRIPTION

<b>LED Light source</b>	High Power LED
<b>Light Color</b>	RGB,CW,WW,NW,Red,Green,Blue,Amber
<b>Material</b>	SUS316
<b>Optics</b>	S10° / F40°
<b>Power</b>	8W
<b>Power supply</b>	N/A
<b>Dimension</b>	D96X47
<b>Weight</b>	940g
<b>IP Rating</b>	IP67
<b>Approvals</b>	CE,RoHS,IP
<b>Ambient temperature</b>	-20°C ~ +45°C
<b>Average life</b>	50,000Hrs
<b>Accessories(Optional)</b>	N/A
<b>Applications</b>	Indoor/Outdoor/Landscape/Submersible



Model No.	LED Brand	Color	Beam	PowerMode	Input	Wiring	Cable	Power	Luminous Flux	Dimension	DrillSize
LP268	CREE	CW,WW, NW,Red Green,Blue,Amber	S10/F40	Constant current	350mA	Series	3M 2X0.75mm <sup>2</sup> Cable	8W	800LM	D96X47	N/A
LP268D	CREE	CW,WW, NW,Red Green,Blue,Amber	S10/F40	Constant voltage	24VDC	Parallel	3M 2X0.75mm <sup>2</sup> Cable	9W	800LM	D96X47	N/A
LP268RGB	CREE	RGB(3R+3G+2B)	S10/F40	Constant current	350mA	Series	2x3M 4X0.5mm <sup>2</sup> Cable	8W	N/A	D96X47	N/A

\*IES Data support.

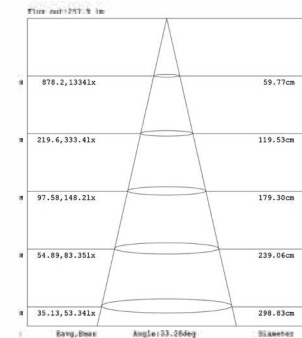
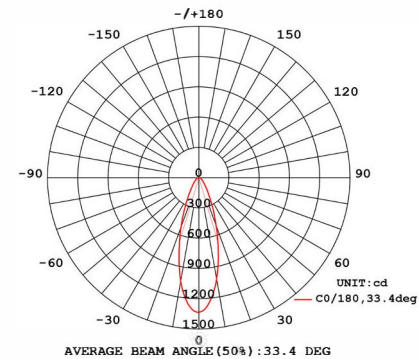





# LINE LIGHTING

SPECIALIZED MANUFACTURER  
LED LIGHTING PRODUCTS



## LP2001 LINE LIGHTING



### DESCRIPTION

<b>LED Light source</b>	High Power LED
<b>Light Color</b>	CW,WW,NW,Red,Green,Blue,Amber,RGB,RGBW
<b>Material</b>	Aluminum
<b>Optics</b>	S20° / F60°
<b>Power</b>	2W
<b>Power supply</b>	24VDC
<b>Dimension</b>	L69xW44xH41
<b>Weight</b>	150g
<b>IP Rating</b>	IP66
<b>Approvals</b>	CE,RoHS
<b>Ambient temperature</b>	-20°C ~ +45°C
<b>Average life</b>	50,000Hrs
<b>Accessories(Optional)</b>	N/A
<b>Applications</b>	Indoor/Outdoor



### LED Colours

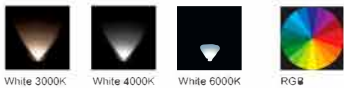

White 3000K White 4000K White 6000K RGB

### LP2001

Square recessed fixture complete with integral CREE LED package and 18 degree beam option. Tempered glass, Aluminum option with construction rated to IP66. Small Product footprint ensures versatile application. Easy to install into the panels.

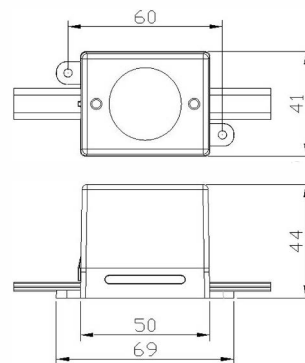

Model No.	LED Brand	Color	Beam	PowerMode	Input	Wiring	Cable	Power	Luminous Flux	Dimension	DrillSize
LP2001D	CREE	CW,WW,NW,Red,Green,Blue,Amber	S20° / F60°	Constant voltage	24VDC	Parallel	0.5M 2X1.0mm <sup>2</sup> Cable	2W	150LM	L69xW44xH41	N/A
LP2001DMX	CREE	CW,WW,NW,Red,Green,Blue,Amber	S20° / F60°	Constant voltage DMX	24VDC DMX	Parallel	0.5M 2X1.0mm <sup>2</sup> +4*0.2mm Cable	2W	150LM	L69xW44xH41	N/A
LP2001DMX	EDISON	RGB,RGBW	S20° / F60°	Constant voltage DMX	24VDC DMX	Parallel	0.5M 2X1.0mm <sup>2</sup> +4*0.2mm Cable	3W	50LM	L69xW44xH41	N/A

DMX decoder in built

\*IES Data support.

\*Length could be customized

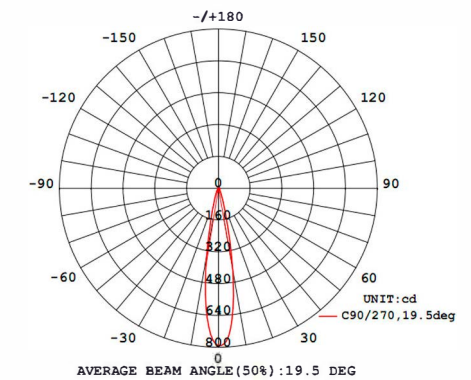
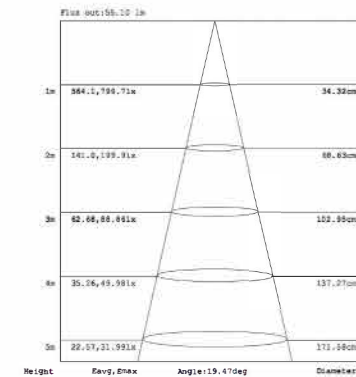



## LP26 LINE LIGHTING



### LED Colours



### LP26

Recessed linear fixture rated to IP65. Wall/ floor-recessed luminaire for use with fluorescent lamps and LEDs. Tempered glass with integrated OSRAM LED chipset. Luminaire ready for pass-through wiring.



### DESCRIPTION

<b>LED Light source</b>	SMD LED
<b>Light Color</b>	RGB,CW,WW,NW,Red,Green,Blue,Amber
<b>Material</b>	Aluminum
<b>Optics</b>	120°
<b>Power</b>	12W / 6.5W
<b>Power supply</b>	N/A
<b>Dimension</b>	1000x45x48 / 500x45x48
<b>Weight</b>	500g / 340g
<b>IP Rating</b>	IP65
<b>Approvals</b>	CE,RoHS,IP
<b>Ambient temperature</b>	-20°C ~ +45°C
<b>Accessories(Optional)</b>	N/A
<b>Applications</b>	Indoor / Outdoor

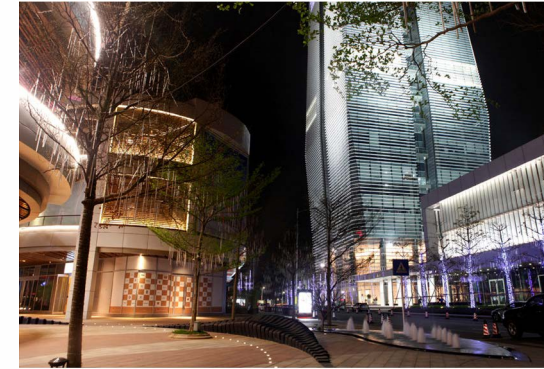

Model No.	LED Brand	Color	Beam	PowerMode	Input	Wiring	Cable	Power	Luminous Flux	Dimension	DrillSize
LP2 6	OSRAM	CW,WW, NW,Red Green,Blue,Amber	120	Constant voltage	24VDC	Parallel	0.2M 2X1.0mm <sup>2</sup> plug	12W	1000LM	1000X45X48	N/A
LP2 6-0.5M	OSRAM	CW,WW, NW,Red Green,Blue,Amber	120	Constant voltage	24VDC	Parallel	0.2M 2X1.0mm <sup>2</sup> plug	6.5W	500LM	500X45X48	N/A
LP26DMX-RGB	EDISON	RGB	120	Constant voltage	24VDC DMX Controller	Parallel	0.2M 4X0.5mm <sup>2</sup> plug	12W	N/A	1000X45X48	N/A
LP2 6-0.5M-DMX-RGB	EDISON	RGB	120	Constant voltage	24VDC DMX Controller	Parallel	0.2M 4X0.5mm <sup>2</sup> plug	6.5W	N/A	500X45X48	N/A

DMX decoder in built

\*IES Data support.

\*Length could be customized

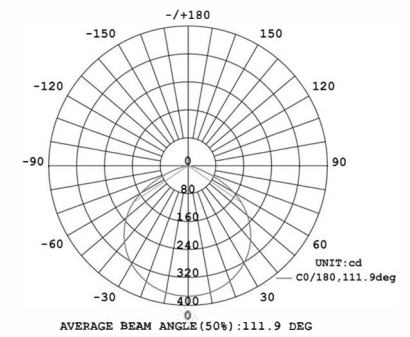
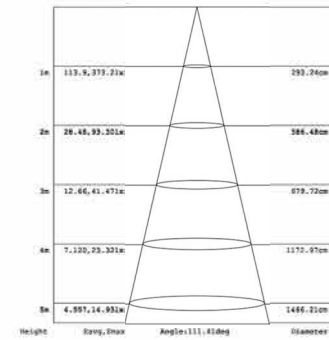

## LP26HP LINE LIGHTING



### DESCRIPTION

<b>LED LIGHT SOURCE</b>	High Power LED
<b>LIGHT COLOR</b>	CW,WW,NW,Red,Green,Blue,Amber
<b>MATERIAL</b>	Aluminum
<b>OPTICS</b>	10° / 20° / 40° / 60°
<b>POWER</b>	18W/9W
<b>POWER SUPPLY</b>	N/A
<b>DIMENSION</b>	1000x45x48 / 500x45x48
<b>WEIGHT</b>	650g/395g
<b>IP RATING</b>	IP65
<b>APPROVALS</b>	CE,RoHS,IP
<b>AMBIENT TEMPERATURE</b>	-20°C ~ +45°C
<b>ACCESSORIES(OPTIONAL)</b>	N/A
<b>APPLICATIONS</b>	Indoor / Outdoor



### LED Colours



White 3000K   White 4000K   White 6000K   RGB

### LP26HP

Recessed linear fixture rated to IP65. Wall/ floor-recessed luminaire for use with fluorescent lamps and LEDs. Tempered glass with integrated CREE XPE LED chipset. Luminaire ready for pass-through wiring.

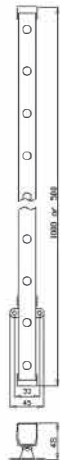

Model No.	LED Brand	Color	Beam	PowerMode	Input	Wiring	Cable	Power	Luminous Flux	Dimension	DrillSize
LP26HP-1M-18	CREE	CW,WW, NW,Red Green,Blue,Amber	10/20/40/60	Constant voltage	24VDC	Parallel	0.2M 2X1.0mm <sup>2</sup> plug	20W	1000LM	1000X45X48	N/A
LP26HP-0.5M-9	CREE	CW,WW, NW,Red Green,Blue,Amber	10/20/40/60	Constant voltage	24VDC	Parallel	0.2M 2X1.0mm <sup>2</sup> plug	10W	500LM	500X45X48	N/A

\*IES Data support.  
\*Length could be customized

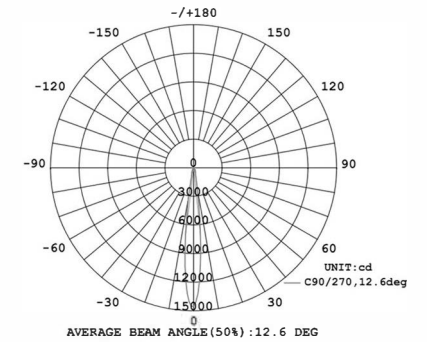
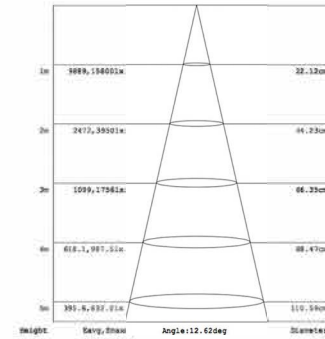

## LP27 LINE LIGHTING

### DESCRIPTION

<b>LED LIGHT SOURCE</b>	High Power LED
<b>LIGHT COLOR</b>	CW,WW,NW,Red,Green,Blue,Amber
<b>MATERIAL</b>	Aluminum
<b>OPTICS</b>	120°
<b>POWER</b>	10W
<b>POWER SUPPLY</b>	N/A
<b>DIMENSION</b>	1000X17X33
<b>WEIGHT</b>	N/A
<b>IP RATING</b>	IP65
<b>APPROVALS</b>	CE,RoHS,IP
<b>AMBIENT TEMPERATURE</b>	-20°C ~ +45°C
<b>ACCESSORIES(OPTIONAL)</b>	N/A
<b>APPLICATIONS</b>	Indoor/Outdoor

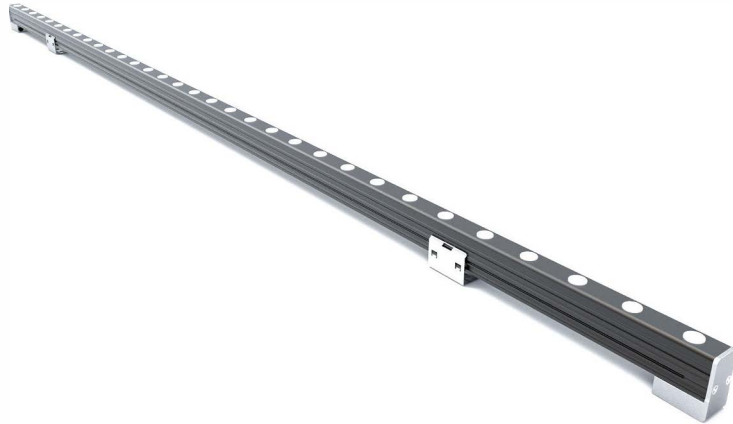

Model No.	LED Brand	Color	Beam	PowerMode	Input	Wiring	Cable	Power	Luminous Flux	Dimension	DrillSize
LP27-DMX-RGB	OSRAM	RGB	120	Constant voltage	DMX24VDC	Parallel	0.2M 4X0.5mm <sup>2</sup> plug	10W	N/A	1000X17X33	N/A

\*IES Data support.  
\*Length could be customized

### LED Colours



White 3000K    White 4000K    White 6000K

### LP27

Recessed linear fixture rated to IP65. Wall/floor-recessed luminaire for use with fluorescent lamps and LEDs. Tempered glass with integrated OSRAM LED chipset. Luminaire ready for pass-through wiring.

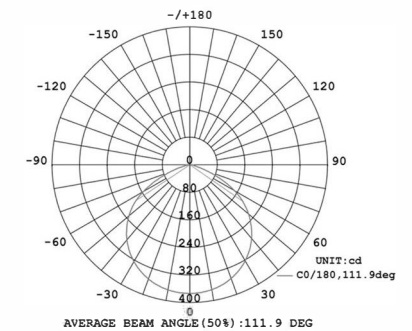
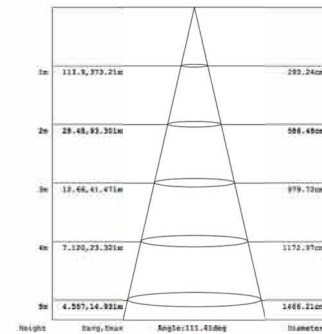



## LP700D LINE LIGHTION



### LED Colours

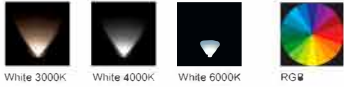

White 3000K White 4000K White 6000K RGB

### LP700

Recessed linear fixture rated to IP67. Wall/ floor-recessed luminaire for use with fluorescent lamps and LEDs. Tempered glass with integrated CREE XPE LED chipset. Luminaire ready for pass-through wiring.

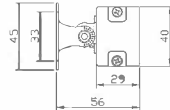
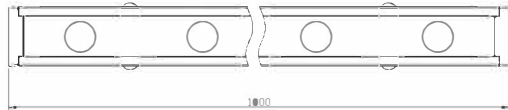

### DESCRIPTION

<b>LED Light source</b>	High Power LED
<b>Light Color</b>	RGB,CW,WW,NW,Red,Green,Blue,Amber
<b>Material</b>	Aluminum
<b>Optics</b>	10° / 20° / 40° / 60°
<b>Power</b>	N/A
<b>Power supply</b>	N/A
<b>Dimension</b>	1000X45XH56
<b>Weight</b>	1.8KG
<b>IP Rating</b>	IP67
<b>Approvals</b>	CE,RoHS,IP
<b>Ambient temperature</b>	-20°C ~ +45°C
<b>Average life</b>	50,000Hrs
<b>Accessories(Optional)</b>	N/A
<b>Applications</b>	Indoor/Outdoor

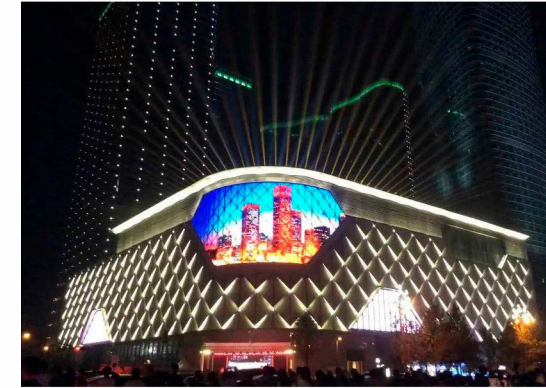

Model No.	LED Brand	Color	Beam	PowerMode	Input	Wiring	Cable	Power	Luminous Flux	Dimension	DrillSize
LP700D-1M-12	CREE	CW,WW, NW,Red Green,Blue,Amber	10/S20/40/F60	Constant voltage	24VDC	Parallel	0.5M 2X0.75mm <sup>2</sup> Cable or 0.2M Plug	13W	1200LM	1000X45XH56	N/A
LP7000-1M-24	CREE	CW,WW, NW,Red Green,Blue,Amber	10/S20/40/F60	Constant voltage	24VDC	Parallel	0.5M 2X0.75mm <sup>2</sup> Cable or 0.2M Plug	26W	2400LM	1000X45XH56	N/A
LP7000-0.5M-6	CREE	CW,WW, NW,Red Green,Blue,Amber	10/S20/40/F60	Constant voltage	24VDC	Parallel	0.5M 2X0.75mm <sup>2</sup> Cable or 0.2M Plug	6.5W	600LM	500X45XH56	N/A
LP7000-0.5M-12	CREE	CW,WW, NW,Red Green,Blue,Amber	10/S20/40/F60	Constant voltage	24VDC	Parallel	0.5M 2X0.75mm <sup>2</sup> Cable or 0.2M Plug	13W	1200LM	500X45XH56	N/A
LP7000-0.3M-4	CREE	CW,WW, NW,Red Green,Blue,Amber	10/S20/40/F60	Constant voltage	24VDC	Parallel	0.5M 2X0.75mm <sup>2</sup> Cable or 0.2M Plug	4.5W	400LM	300X45XH56	N/A
LP7000-1M-12-M	CREE	CW,WW, NW,Red Green,Blue,Amber	120	Constant voltage	24VDC	Parallel	0.5M 2X0.75mm <sup>2</sup> Cable or 0.2M Plug	13W	1200LM	1000X45XH56	N/A
LP700-1M-12-DMX	CREE	CW,WW, NW, Red,Green,Blue,Amber	10/S20/40/F60	Constant voltage	24VDC DMX Controller	Parallel	0.5M 4X0.5mm <sup>2</sup> Cable or 0.2M Plug	13W	1200LM	1000X45XH56	N/A
LP700-1M-24-DMX	CREE	CW,WW, NW, Red,Green,Blue,Amber	10/S20/40/F60	Constant voltage	24VDC DMX Controller	Parallel	0.5M 4X0.5mm <sup>2</sup> Cable or 0.2M Plug	26W	2400LM	1000X45XH56	N/A
LP700-1M-16-DMX-RGBW	CREE	4R+4G+4B+4W	10/S20/40/F60	Constant voltage	24VDC DMX Controller	Parallel	0.5M 4X0.5mm <sup>2</sup> Cable or 0.2M Plug	17W	N/A	1000X45XH56	N/A

DMX decoder in built

\*IES Data support  
\*Length could be customized

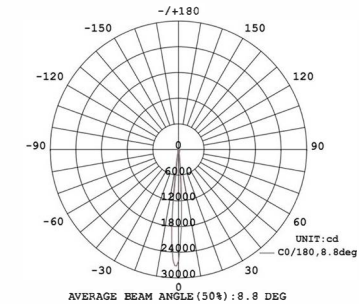
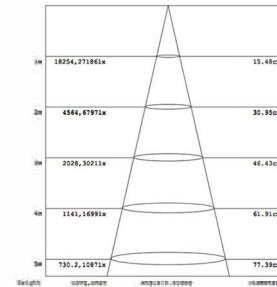

LP710 GROUND LIGHT

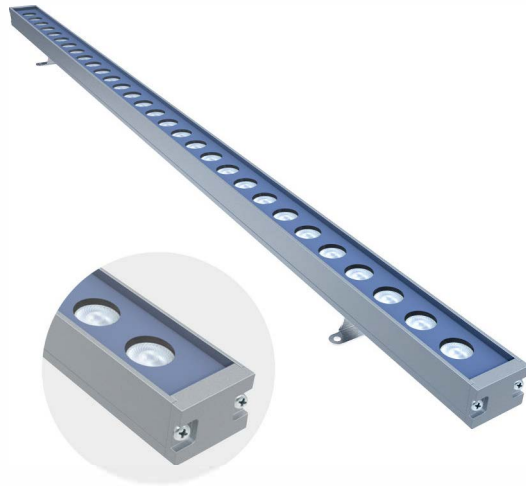

LED Colours



LP700

Recessed linear fixture rated to IP67. Wall/ floor-recessed luminaire for use with fluorescent lamps and LEDs. Tempered glass with integrated CREE XPE LED chipset. Luminaire ready for pass-through wiring

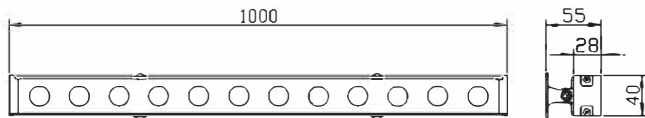

DESCRIPTION

LED Light source	High Power LED
Light Color	RGB,CW,WW,NW,Red,Green,Blue,Amber
Material	Aluminum
Optics	15° / 20° / 30° / 45° / 60°
Power	12W
Power supply	24VDC
Dimension	1000X40XH55
Weight	N/A
IP Rating	IP67
Approvals	CE,RoHS,IP
Ambient temperature	-20°C ~ +45°C
Accessories(Optional)	N/A
Applications	Indoor/Outdoor



MODEL NO.	LED Brand	Color	BEAM	PowerMode	Input	Wiring	Power	Luminous	Dimention	DrillSize
LP710D	CREE	CW,WW, NW,Red Green,Blue,Amber	15/S20/30/45/F60	Constant voltage	24VDC	Parallel	12W	800LM	1000X40XH55	N/A
LP710DM	CREE	CW,WW, NW,Red Green,Blue,Amber	120	Constant voltage	24VDC	Parallel	12W	500LM	1000X40XH55	N/A
LP710DMX-RGB	CREE	4R+4G+4B	15/S20/30/45/F60	Constant voltage	24VDC DMX Controller	Parallel	12W	N/A	1000X40XH55	N/A
LP710-1M-12W -DMX-RGB	Edison	RGB(FullColor)	15/S20/30/45/F60	Constant voltage	24VDC DMX Controller	Parallel	12W	N/A	1000X40XH55	N/A

DMX decoder is built

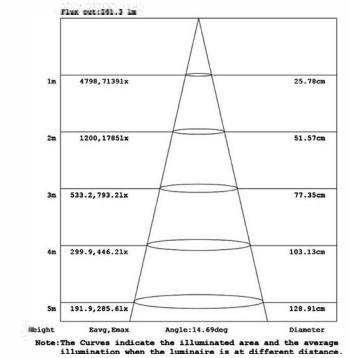
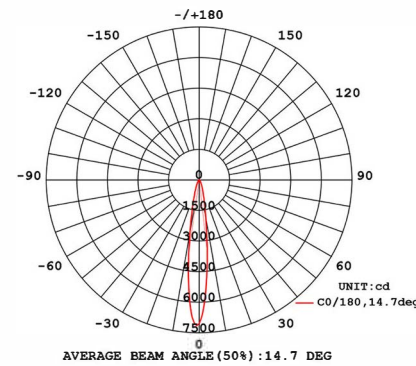





# LED COMPONENTS

SPECIALIZED MANUFACTURER  
LED LIGHTING PRODUCTS



## LPD03 LED COMPONENTS



### LED Colours



White 3000K    White 4000K    White 6000K    RGB

### LPD03

A 50mm MR16 LED for retrofitting into existing LV housings, including ground lights, down lights, and wall lights. Tempered glass. The three high-power LEDs within this 3W unit come in a range of LED colors and emit the same intensity of light as a 20W halogen. It has a short rear heat sink for fitting into shallow housings, and a choice of flood (60°) or spot (20°) lens formats.

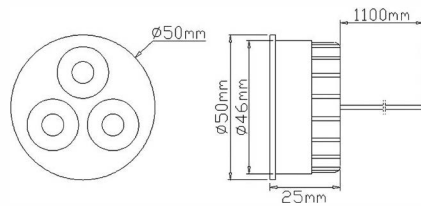

### DESCRIPTION

<b>LED Light source</b>	High Power LED
<b>Light Color</b>	RGB,CW,WW,NW,Red,Green,Blue,Amber
<b>Material</b>	Aluminum
<b>Optics</b>	S20° / F60°
<b>Power</b>	3W
<b>Power supply</b>	N/A
<b>Dimension</b>	D50X25
<b>Weight</b>	100g
<b>IP Rating</b>	IP40
<b>Approvals</b>	CE,RoHS,IP
<b>Average life</b>	50,000Hrs
<b>Accessories(Optional)</b>	N/A
<b>Applications</b>	Indoor



Model No.	LED Brand	Color	Beam	PowerMode	Input	Wiring	Cable	Power	Luminous Flux	Dimension	DrillSize
LPD03	CREE	CW,WW, NW,Red Green,Blue,Amber	S20/F60	Constant current	350mA	Series	1.1M 2X24AWG Cable	3W	300LM	D50X25	D47
LPD03RGB	CREE	RGB	S20/F60	Constant current	RGB350mA	Series	2x1.1M 4X24AWG Plug	3W	N/A	D50X25	D47

\*IES Data support.

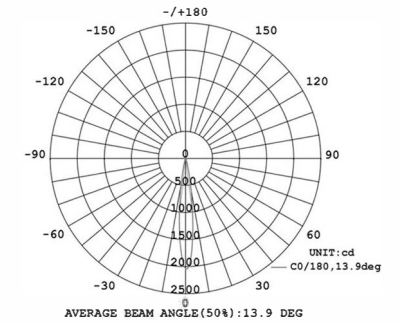
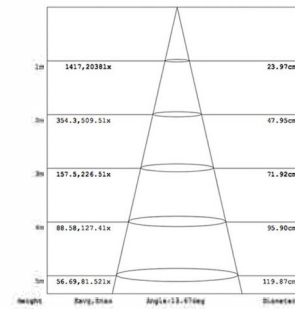

## LPD09 LED COMPONENTS



## DESCRIPTION

<b>LED Light source</b>	High Power LED
<b>Light Color</b>	RGB,CW,WW,NW,Red,Green,Blue,Amber
<b>Material</b>	Aluminum
<b>Optics</b>	S20° / F60°
<b>Power</b>	9W
<b>Power supply</b>	N/A
<b>Dimension</b>	D50X55
<b>Weight</b>	150g
<b>IP Rating</b>	IP40
<b>Approvals</b>	CE,RoHS,IP
<b>Average life</b>	50,000Hrs
<b>Applications</b>	Indoor



Model No.	LED Brand	Color	Beam	PowerMode	Input	Wiring	Cable	Power	Luminous Flux	Dimension	DrillSize
LPD09	CREE	CW,WW, NW,Red Green,Blue,Amber	S20/F60	Constant current	700mA	Series	1.1M 2X24AWG Cable	9W	N/A	D50X55	D47
LPD09RGB	CREE	RGB	45	Constant current	RGB350mA	Series	1.1M 4X24AWG Plug	9W	N/A	D50X55	D47

\*IES Data support.

## LPD09

This low-energy, 50mm MR16 LED unit is a cost-saving alternative to expensive and maintenance hungry LV and GU halogens. It's a zero maintenance replacement that fits straight into existing LV housings, including ground lights, down lights, and wall lights. Tempered glass. The three high-power LEDs within this 9W lamp emit more light than a 35W halogen, yet they run at a fraction of the cost.

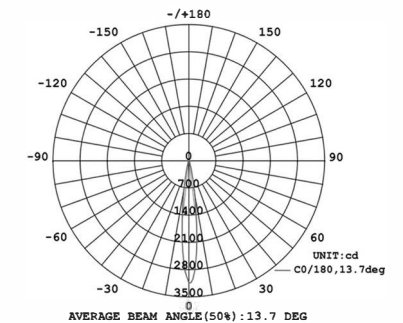
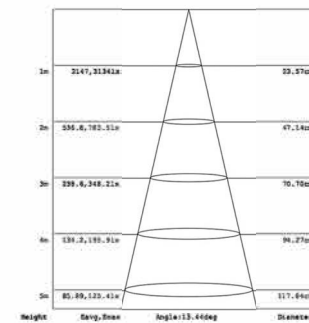
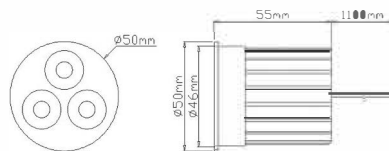





# WALL LIGHT

SPECIALIZED MANUFACTURER  
LED LIGHTING PRODUCTS



## LP1808 WALL LIGHT

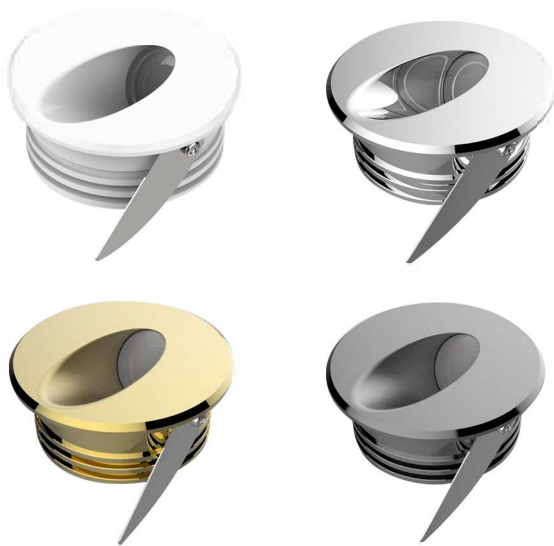

### LED Colours



### LP1808

Miniature recessed fixture complete with integral CREE LED package and 10/20/30/60 degree beam option. Aluminum surface mounted projector. Tempered glass with construction rated to IP44 with single aperture for asymmetric emission. Product footprint of 64mm diameter ensures versatile application. Easy to install into the panels.

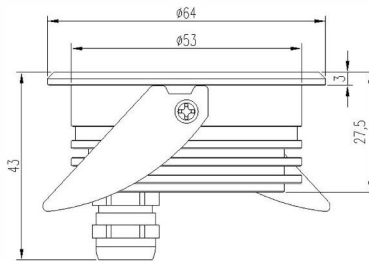

### DESCRIPTION

<b>LED Light source:</b>	High Power LED
<b>Light Color:</b>	CW, WW, NW, Red, Green, Blue, Amber
<b>Material:</b>	Aluminum
<b>Optics:</b>	60°
<b>Power:</b>	1W/3W
<b>Power supply:</b>	N/A
<b>Dimension:</b>	D64X43
<b>Weight:</b>	170g
<b>IP Rating:</b>	IP44
<b>Approvals:</b>	CE, RoHS
<b>Ambient temperature:</b>	-20°C~+45°C
<b>Average Life:</b>	50,000Hrs
<b>Accessories(Optional):</b>	N/A
<b>Applications:</b>	Indoor



Model No.	LED Brand	Color	Beam	PowerMode	Input	Wiring	Cable	Power	Luminous Flux	Dimension	DrillSize
LP1808	CREE	CW, WW, NW, Red, Green, Blue, Amber	60°	Constant current	350mA	Series	0.5m 2*0.75 H05RN-F Cable	1W	95LM	D64X43	D60
LP1808-3W	CREE	CW, WW, NW, Red, Green, Blue, Amber	60°	Constant current	700mA	Series	0.5m 2*0.75 H05RN-F Cable	3W	160LM	D64X43	D60

\*IES Data support.

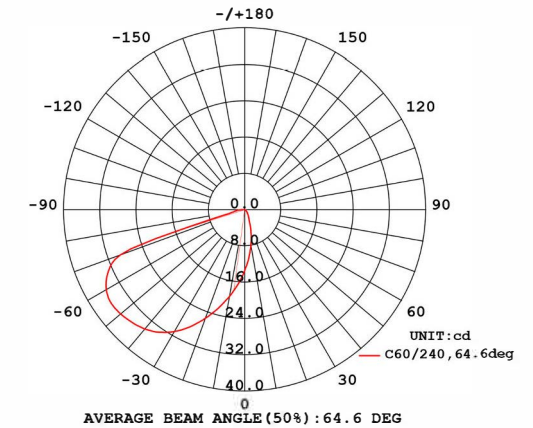
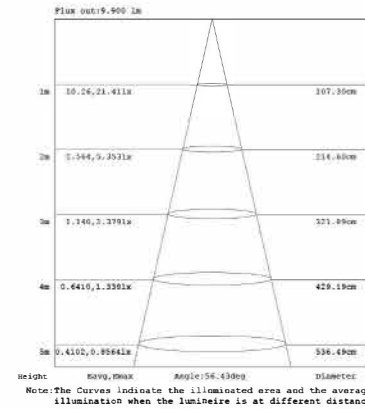

## LP1820 WALL LIGHT



### DESCRIPTION

<b>LED Light source</b>	LED
<b>Light Color</b>	CW,WW,NW,Red,Green,Blue,Amber
<b>Material</b>	Aluminum
<b>Optics</b>	70°
<b>Power</b>	1W / 0.3W
<b>Power supply</b>	350mA/24VDC
<b>Dimension</b>	D24XH25
<b>Weight</b>	30g
<b>IP Rating</b>	IP65
<b>Approvals</b>	CE,RoHS
<b>Ambient temperature</b>	-20°C ~ +45°C
<b>Average life</b>	50,000Hrs
<b>Accessories(Optional)</b>	YES
<b>Applications</b>	Indoor

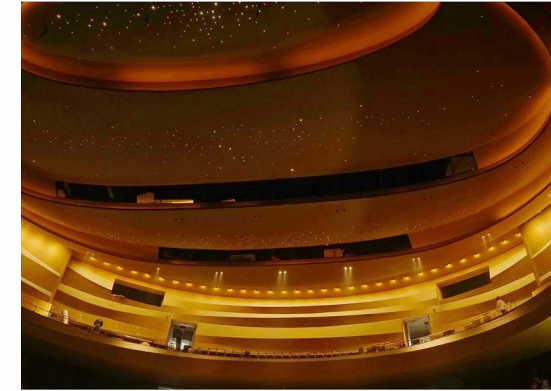

### LED Colours



White 3000K White 4000K White 6000K RGB

### LP1820

Miniature recessed fixture complete with integral OSRAM LED package and 70 degree beam option. IP65 wall light is made of Aluminum. Frosted optic serves to minimize glare coupled with a diffuse beam distribution. Small Product footprint ensures versatile application. Easy to install into the panels.

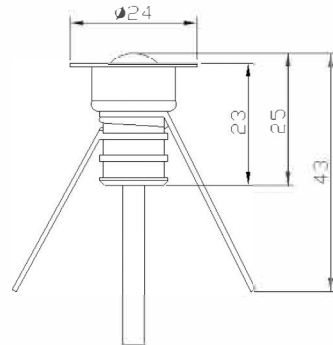

Model No.	LED Brand	Color	Beam	PowerMode	Input	Wiring	Cable	Power	Luminous Flux	Dimension	DrillSize
LP1820	CREE	CW,WW,NW,Red,Green,Blue,Amber	70°	Constant current	350mA	Series	0.5M 2X0.4mm <sup>2</sup> Cable	1W	60LM	D24XH25	D17
LP1820D	CREE	CW,WW,NW,Red,Green,Blue,Amber	70°	Constant voltage	24VDC	Parallel	0.5M 2X0.4mm <sup>2</sup> Cable	1W	60LM	D24XH25	D17
LP1820D-0.3	OSRAM	CW,WW,NW,Red,Green,Blue,Amber	70°	Constant voltage	24VDC	Parallel	0.5M 2X0.4mm <sup>2</sup> Cable	0.3W	20LM	D24XH25	D17

\*IES Data support.

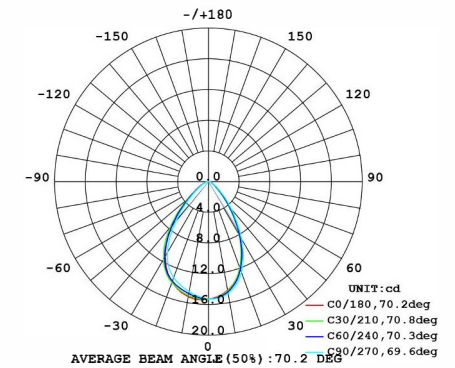
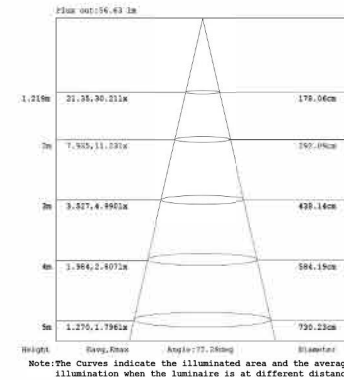

## LP101 WALL LIGHT



### DESCRIPTION

<b>LED Light source</b>	High Power LED
<b>Light Color</b>	RGB,CW,WW,NW,Red,Green,Blue,Amber
<b>Material</b>	SUS316
<b>Optics</b>	N/A
<b>Power</b>	1W
<b>Power supply</b>	N/A
<b>Dimension</b>	D35X28
<b>Weight</b>	70g
<b>IP Rating</b>	IP68
<b>Approvals</b>	CE,RoHS,IP
<b>Ambient temperature</b>	-20°C ~ +45°C
<b>Average life</b>	50,000Hrs
<b>Accessories(Optional)</b>	N/A
<b>Applications</b>	Indoor/Outdoor/Landscape/Submersible

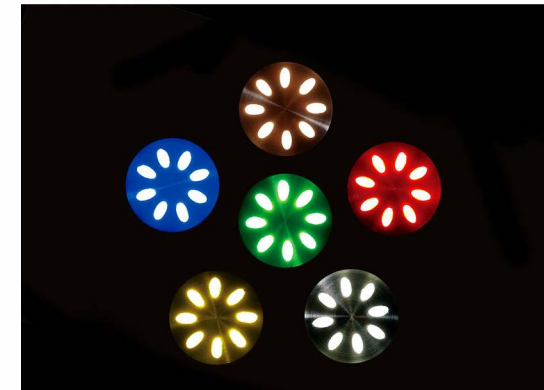

#### LED Colours

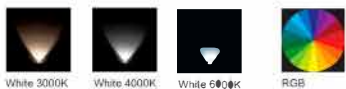

### LP101

A modern day and elegant LED decorative mini-light, it is designed to add style to floors, bars, walls and ceilings. Walkover and IP68 rated. The clever and stylish design of the light output means no glare even when looking directly at it, making this product perfect for stair facings. Using only 1W of energy makes running costs incredibly low, whilst visual impact is high. Tempered glass. Made from marine grade stainless steel and IP rated to 68 ensures you can use this product indoors or out.

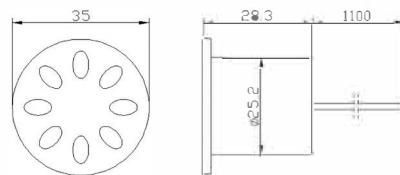

Model No.	LED Brand	Color	Beam	PowerMode	Input	Wiring	Cable	Power	Luminous Flux	Dimension	DrillSize
LP101	CREE	CW,WW, NW,Red Green,Blue,Amber	N/A	Constant current	350mA	Series	1.1M 2X24AWG Cable	1W	N/A	D35X28	D26
LP,101D	CREE	CW,WW, NW,Red Green,Blue,Amber	N/A	Constant voltage	24VDC	Parallel	1.1M 2X24AWG Cable	1.3W	N/A	D35X28	D26
LP101RGB	CREE	RGB	N/A	Constant voltage	RGB24VDC	Parallel	1.1M 4X24AWG Cable	1W	N/A	D35X28	D26

\*IES Data support.

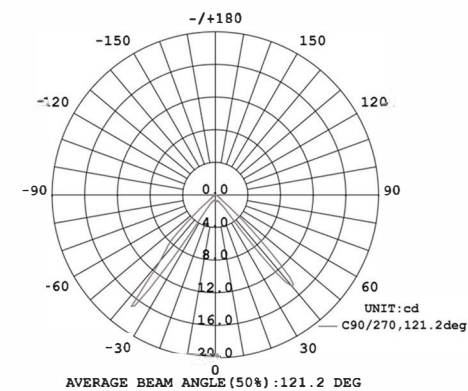



## LP102 WALL LIGHT



LP1022



LP1021

### LED Colours



White 3000K White 4000K White 6000K

### LP102

Miniature display light featuring Stainless Steel construction rated to IP65 making this product suitable for both interior and exterior applications. The product is directional and thus perfect for lighting focal features on the wall or within display cabinets. Tempered glass. Incorporates an integrated CREE USA LED white chip set powered at 1W or 2W. A low energy, no maintenance solution

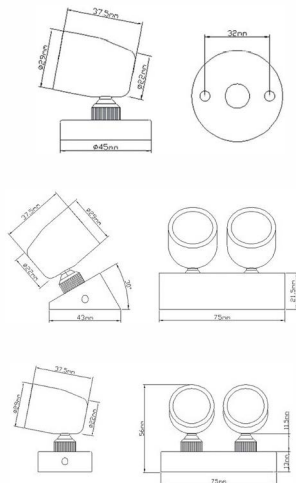

### DESCRIPTION

<b>LED LIGHT SOURCE</b>	High Power LED
<b>LIGHT COLOR</b>	CW,WW,NW,Red,Green,Blue,Amber
<b>MATERIAL</b>	SUS316
<b>OPTICS</b>	S20° / F60°
<b>POWER</b>	1W/2W
<b>POWER SUPPLY</b>	N/A
<b>DIMENSION</b>	N/A
<b>WEIGHT</b>	N/A
<b>IP RATING</b>	IP65
<b>APPROVALS</b>	CE,RoHS,IP
<b>AMBIENT TEMPERATURE</b>	-20°C ~ +45°C
<b>AVERAGE LIFE</b>	50,000Hrs
<b>ACCESSORIES(OPTIONAL)</b>	N/A
<b>APPLICATIONS</b>	Indoor/Outdoor/Landscape

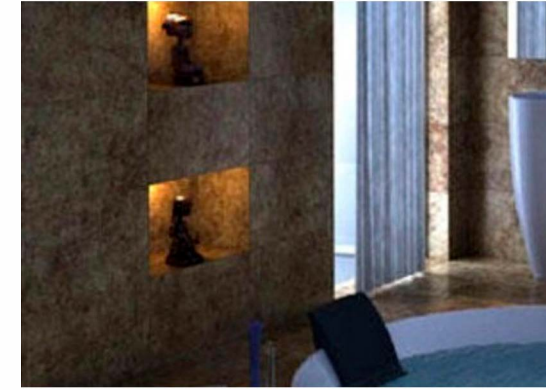

Model No.	LED Brand	Color	Beam	PowerMode	Input	Wiring	Cable	Power	Luminous Flux	Dimension	DrillSize
LP1021	CREE	CW,WW, NW,Red Green,Blue,Amber	S20/F60	Constant current	350mA	Series	1W	1.1M 2X24AWG Cable	100LM	D45X53	N/A
LP1022	CREE	CW,WW, NW,Red Green,Blue,Amber	S20/F60	Constant current	350mA	Series	2W	1.1M 2X24AWG Cable	200LM	35X75X56	N/A
LP1022-30	CREE	CW,WW, NW,Red Green,Blue,Amber	S20/F60	Constant current	350mA	Series	2W	1.1M 2X24AWG Cable	200LM	43X75X56	N/A

\*IES Data support.

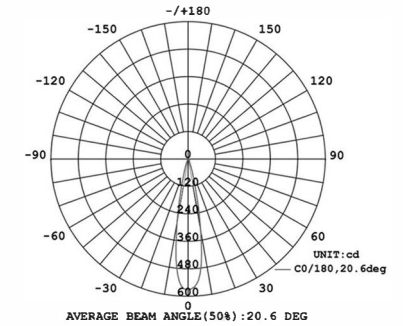
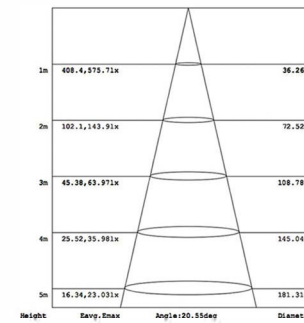

## LP102-L WALL LIGHT



LP102-L

ML102-2L

### LED Colours



White 3000K    White 4000K    White 6000K

### LP102-L

Mini wall lights are stylish and functional. Great for lighting pictures and focal items, as well as using for reading or simply adding style to walls, wooden beams and ceilings. Tempered glass. Made from marine grade stainless and IP rated to 40 allows for installation both indoor. You can chose from 6 ambient LED colors and 3 wall mounting brackets to suit any lighting scheme.

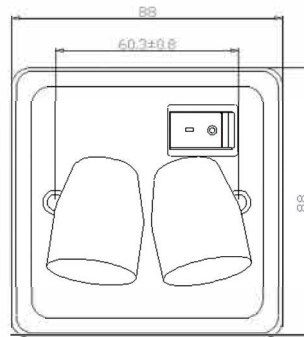

### DESCRIPTION

<b>LED LIGHT SOURCE</b>	High Power LED
<b>LIGHT COLOR</b>	CW,WW,NW,Red,Green,Blue,Amber
<b>MATERIAL</b>	SUS316
<b>OPTICS</b>	S20° / F60°
<b>POWER</b>	1W/2W
<b>POWER SUPPLY</b>	N/A
<b>DIMENSION</b>	N/A
<b>WEIGHT</b>	N/A
<b>IP RATING</b>	IP40
<b>APPROVALS</b>	CE,RoHS
<b>ACCESSORIES(OPTIONAL)</b>	N/A
<b>APPLICATIONS</b>	Indoor



MODEL NO.	LED Brand	Color	BEAM	PowerMode	Input	Wiring	Power	Luminous	Dimention	DrillSize
LP102-L	CREE	CW,WW, NW,Red Green,Blue,Amber	S20/F60	Constant voltage	100-240VAC	Parallel	1W	100LM	88X88X80	N/A
LP102-2L	CREE	CW,WW, NW,Red Green,Blue,Amber	S20/F60	Constant voltage	100-240VAC	Parallel	2W	200LM	88X98X80	N/A

\*IES Data support.

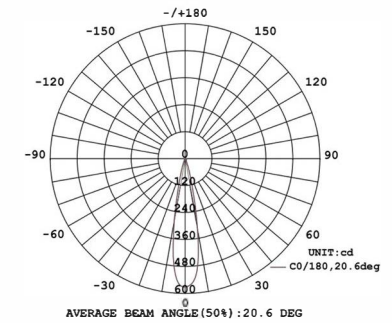
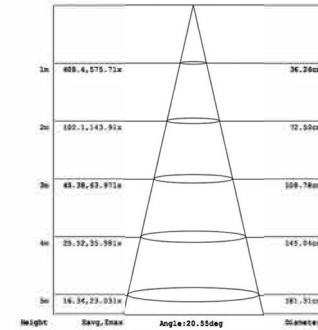

LP103 WALL LIGHT



LED Colours



LP103

Add impact to any area with the LP103 wall light. An elegant 'halo' effect is created around the unit in a choice of 7 ambient LED colors. Tempered glass. Finished to a high standard using anodized aluminum, this trendy mini-light will look great in superior establishments and homes.

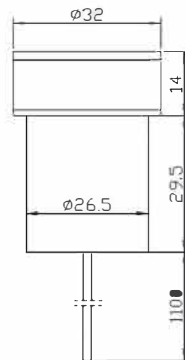

DESCRIPTION

<b>LED LIGHT SOURCE</b>	High Power LED
<b>LIGHT COLOR</b>	RGB,CW,WW,NW,Red,Green,Blue,Amber
<b>MATERIAL</b>	Aluminum
<b>OPTICS</b>	N/A
<b>POWER</b>	1W
<b>POWER SUPPLY</b>	N/A
<b>DIMENSION</b>	D32X44
<b>WEIGHT</b>	56g
<b>IP RATING</b>	IP65
<b>APPROVALS</b>	CE,RoHS,IP
<b>AMBIENT TEMPERATURE</b>	-20°C ~ +45°C
<b>AVERAGE LIFE</b>	50,000Hrs
<b>ACCESSORIES(OPTIONAL)</b>	N/A
<b>APPLICATIONS</b>	Indoor/Outdoor

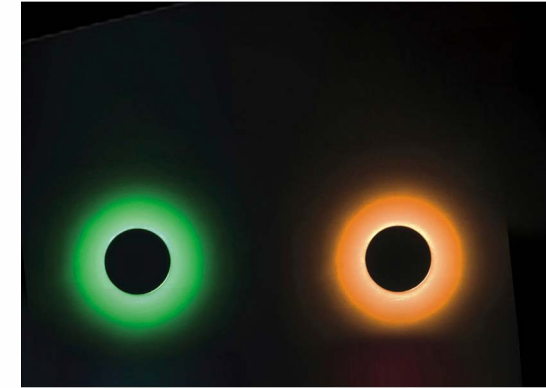

Model No.	LED Brand	Color	Beam	PowerMode	Input	Wiring	Cable	Power	Luminous Flux	Dimension	DrillSize
LP103	CREE	CW,WW, NW,Red Green,Blue,Amber	N/A	Constant current	350mA	Series	1.1M 2X24AWG Cable	1W	N/A	D32X44	D27
LP 1030D	CREE	CW,WW, NW,Red Green,Blue,Amber	N/A	Constant voltage	24VDC	Parallel	1.1M 2X24AWG Cable	1.3W	N/A	D32X44	D27
LP 103RGB	Edison	RGB	N/A	Constant voltage	RGB24VDC	Parallel	1.1M 4X24AWG Cable	1W	N/A	D32X44	D27

\*IES Data support.

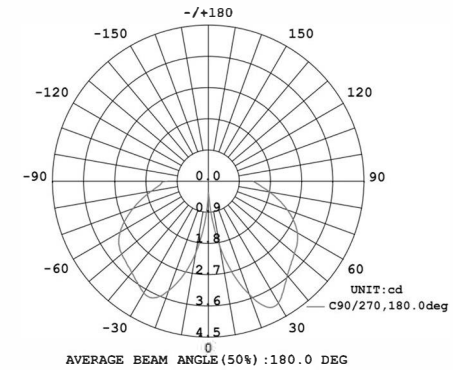



LP104 WALL LIGHT



LED Colours



LP104

Contemporary, chic, yet rugged, the ML104 decorative mini-light adds style to floors, bars, walls and stairs. Tempered glass. Made from marine grade stainless steel and IP rated to 68 ensures you can use this product indoors or out.

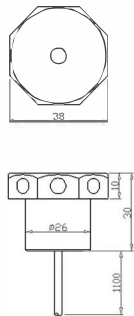

DESCRIPTION

<b>LED LIGHT SOURCE</b>	High Power LED
<b>LIGHT COLOR</b>	RGB,CW,WW,NW,Red,Green,Blue,Amber
<b>MATERIAL</b>	SUS316
<b>OPTICS</b>	N/A
<b>POWER</b>	1W
<b>POWER SUPPLY</b>	N/A
<b>DIMENSION</b>	38X38X30
<b>WEIGHT</b>	110g
<b>IP RATING</b>	IP68
<b>APPROVALS</b>	CE,RoHS,IP
<b>AMBIENT TEMPERATURE</b>	-20°C ~ +45°C
<b>AVERAGE LIFE</b>	50,000Hrs
<b>ACCESSORIES(OPTIONAL)</b>	N/A
<b>APPLICATIONS</b>	Indoor/Outdoor/Landscape/Submersible

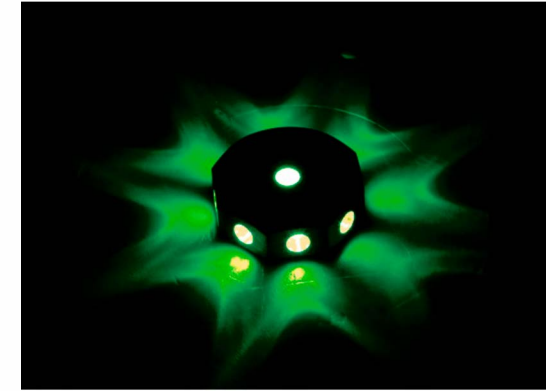

Model No.	LED Brand	Color	Beam	PowerMode	Input	Wiring	Cable	Power	Luminous Flux	Dimension	DrillSize
LP104	CREE	CW,WW, NW,Red Green,Blue,Amber	N/A	Constant current	350mA	Series	1.1M 2X24AWG Cable	1W	N/A	38X38X30	D27
LP 104D	CREE	CW,WW, NW,Red Green,Blue,Amber	N/A	Constant voltage	24VDC	Parallel	1.1M 2X24AWG Cable	1.2W	N/A	38X38X30	D27
LP104RGB	Epison	RGB	N/A	Constant voltage	RGB24VDC	Parallel	1.1M 4X24AWG Cable	1W	N/A	38X38X30	D27

\*IES Data support.

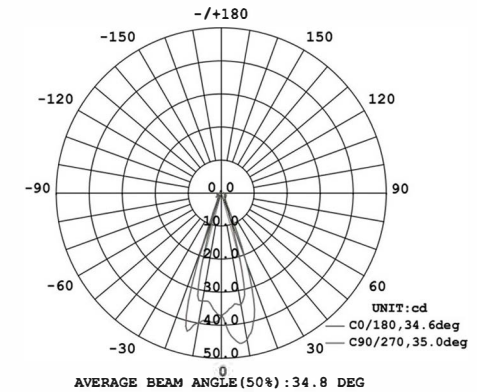

## LP105 WALL LIGHT



### DESCRIPTION

<b>LED LIGHT SOURCE</b>	High Power LED
<b>LIGHT COLOR</b>	CW,WW,NW,Red,Green,Blue,Amber
<b>MATERIAL</b>	Aluminum
<b>OPTICS</b>	S20° / F60°
<b>POWER</b>	1X3W
<b>POWER SUPPLY</b>	N/A
<b>DIMENSION</b>	D45X70
<b>WEIGHT</b>	N/A
<b>IP RATING</b>	IP65
<b>APPROVALS</b>	CE,RoHS,IP
<b>ACCESSORIES(OPTIONAL)</b>	N/A
<b>APPLICATIONS</b>	Indoor/Outdoor



Model No.	LED Brand	Color	Beam	PowerMode	Input	Wiring	Cable	Power	Luminous Flux	Dimension	DrillSize
LP105	CREE	CW,WW, NW,Red Green,Blue,Amber	S20/F60	Constant current	700mA	Series	1.1M 2X24AWG Cable	1X3W	N/A	D45X70	N/A
LP105D	CREE	CW,WW, NW,Red Green,Blue,Amber	S20/F60	Constant voltage	24VDC	Parallel	1.1M 2X24AWG Cable	1X3W	N/A	D45X70	N/A

\*IES Data support.

#### LED Colours



White 3000K White 4000K White 6000K RGB

### LP105

Tempered glass. This anodized aluminum version of our ML105 provides a sleeker, less obtrusive presence in your garden. It gives you the choice of LED colors, wide or narrow beam angles and ±100° tilting head.

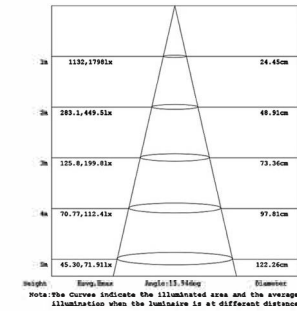
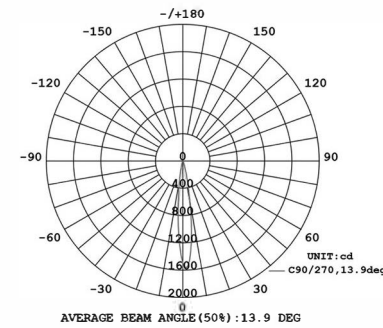
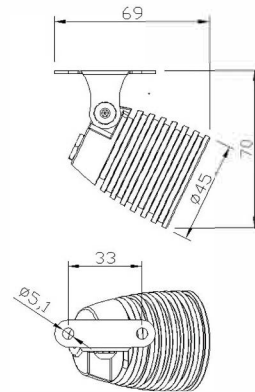

Note: The Curves Indicate the Illuminated area and the average illumination when the luminance is at different distance.



## LP110 WALL LIGHT

## DESCRIPTION

<b>LED LIGHT SOURCE</b>	High Power LED
<b>LIGHT COLOR</b>	CW, WW, NW, Red, Green, Blue, Amber
<b>MATERIAL</b>	Aluminum
<b>OPTICS</b>	S20° / F60°
<b>POWER</b>	1W / 2W
<b>POWER SUPPLY</b>	N/A
<b>DIMENSION</b>	N/A
<b>WEIGHT</b>	100g / 160g
<b>IP RATING</b>	IP65
<b>APPROVALS</b>	CE, RoHS, IP
<b>AMBIENT TEMPERATURE</b>	-20°C ~ +45°C
<b>AVERAGE LIFE</b>	50,000Hrs
<b>ACCESSORIES(OPTIONAL)</b>	
<b>APPLICATIONS</b>	Indoor / Outdoor / Landscape

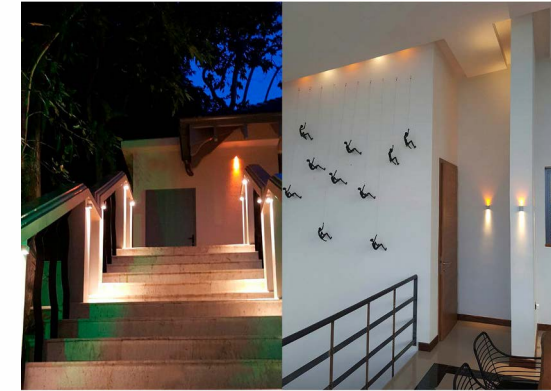

LP110

LP220

Model No.	LED Brand	Color	Beam	PowerMode	Input	Wiring	Cable	Power	Luminous Flux	Dimension	DrillSize
LP110	CREE	CW, WW, NW, Red, Green, Blue, Amber	S20/F60	Constant current	350mA	Series	1.1M 2X24AWG Cable	1W	100LM	35x35x55	D20
LP220	CREE	CW, WW, NW, Red, Green, Blue, Amber	S20/F60	Constant current	350mA	Series	1.1M 2X24AWG Cable	2W	200LM	35x58x55	D20

\*IES Data support.

### LED Colours



White 3000K    White 4000K    White 6000K

### LP110

Stylish, functional and finished to the highest standards in aluminum, this item creates stunning effects on walls in both residential and commercial environments. Using a spot lens keeps the light narrow and direct, sending light over long distances. By using the provided wall plug, installation will be quick and easy, this will also give you the option of adjusting the direction of the light by simply turning the product whilst in the wall. Tempered glass.

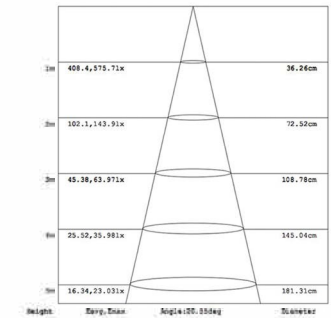
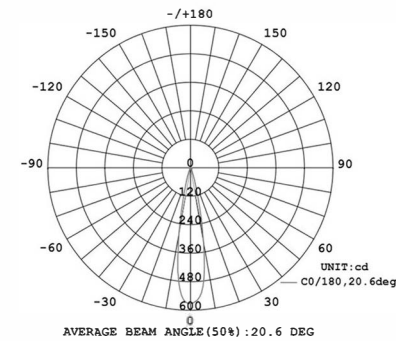
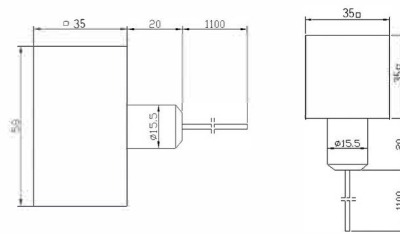



## LP110-L WALL LIGHT



### DESCRIPTION

<b>LED LIGHT SOURCE</b>	High Power LED
<b>LIGHT COLOR</b>	CW, WW, NW, Red, Green, Blue, Amber
<b>MATERIAL</b>	Aluminum
<b>OPTICS</b>	S20° / F60°
<b>POWER</b>	1W
<b>POWER SUPPLY</b>	N/A
<b>DIMENSION</b>	N/A
<b>WEIGHT</b>	N/A
<b>IP RATING</b>	IP40
<b>APPROVALS</b>	CE, RoHS
<b>ACCESSORIES(OPTIONAL)</b>	N/A



MODEL NO.	LED Brand	Color	BEAM	PowerMode	Input	Wiring	Power	Luminous Flux	Dimension	DrillSize
LP110-L	CREE	CW, WW, NW, Red, Green, Blue, Amber	S20/F60	Constant voltage	100-240VAC	Parallel	1W	100LM	88x88x80	N/A
LP220-L	CREE	CW, WW, NW, Red, Green, Blue, Amber	S20/F60	Constant voltage	100-240VAC	Parallel	2W	200LM	88x88x80	N/A

\*IES Data support.

### LED Colours



White 3000K    White 4000K    White 6000K

### LP110-L

Stylish, functional and finished to the highest standards in aluminum, it creates stunning effects on walls in both residential and commercial environments. Using a spot lens keeps the light narrow and direct, sending light over long distances. Complete with an integral power supply, wall fixings and pattress box, making installation quick and easy. Tempered glass.

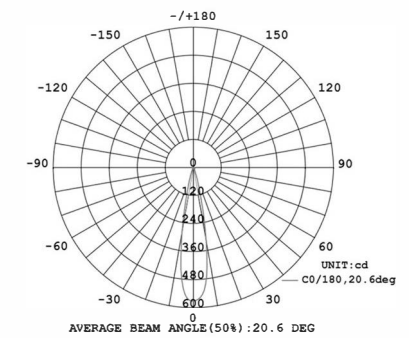
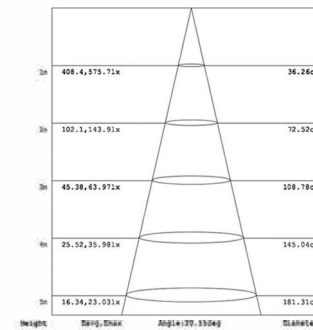
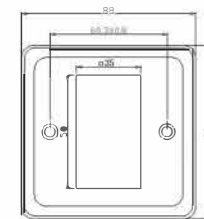
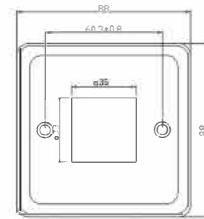

## LP305 WALL LIGHT



### LED Colours



### LP305

Stylish, functional and finished to the highest standards in aluminum, Tempered glass, it creates stunning effects on walls in both residential and commercial environments. Using a spot lens keeps the light narrow and direct, sending light over long distances.

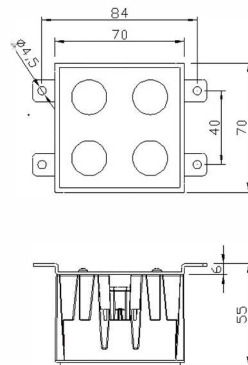

### DESCRIPTION

<b>LED Light source</b>	High Power LED
<b>Light Color</b>	CW,WW,NW,Red,Green,Blue,Amber
<b>Material</b>	Aluminum
<b>Optics</b>	S8° / F60°
<b>Power</b>	4x1W
<b>Power supply</b>	N/A
<b>Dimension</b>	94X70X55
<b>Weight</b>	280g
<b>IP Rating</b>	IP65
<b>Approvals</b>	CE,RoHS,IP
<b>Ambient temperature</b>	-20°C ~ +45°C
<b>Average life</b>	50,000Hrs
<b>Accessories(Optional)</b>	N/A
<b>Applications</b>	Indoor / Outdoor



Model No.	LED Brand	Color	Beam	PowerMode	Input	Wiring	Cable	Power	Luminous Flux	Dimension	DrillSize
LP305	CREE	CW,WW,NW,Red Green,Blue,Amber	S8° / F60°	Constant current	700mA	Series	1.1M 2X24AWG Cable	4X3W	1000LM	94X70X55	N/A
LP305D	CREE	CW,WW,NW,Red Green,Blue,Amber	S8° / F60°	Constant voltage	24VDC (External power)	Parallel	0.2M 2X0.75mm2 Cable	4X3W	1000LM	94X70X55	N/A

\*IES Data support.

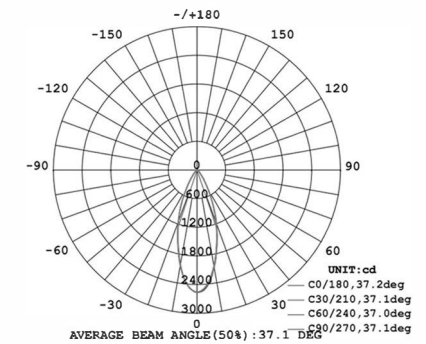
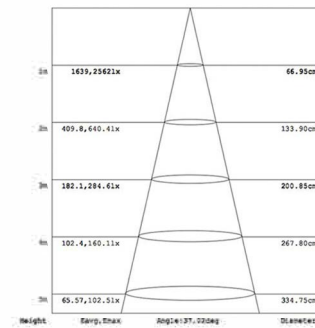





# SPIKE LIGHT

SPECIALIZED MANUFACTURER  
LED LIGHTING PRODUCTS



## LP100 SPIKE LIGHT



### LED Colours



### LP100

This black anodized aluminum version of our SL100 spike light provides less obtrusive presence in your garden. Tempered glass. It gives you the (choice of LED colors, wide or narrow beam angles and 135° tilting head.

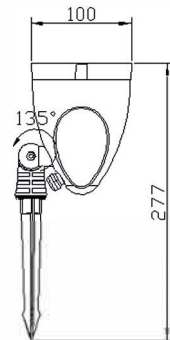

### DESCRIPTION

<b>LED Light source</b>	COB LED
<b>Light Color</b>	CW,WW,NW
<b>Material</b>	Aluminum
<b>Optics</b>	S24° / 40° / F60°
<b>Power</b>	16W
<b>Power supply</b>	24VDC
<b>Dimension</b>	D100X277
<b>Weight</b>	750g
<b>IP Rating</b>	IP65
<b>Approvals</b>	CE,RoHS,IP
<b>Ambient temperature</b>	-20°C ~ +45°C
<b>Average life</b>	50,000Hrs
<b>Accessories(Optional)</b>	N/A
<b>Applications</b>	Indoor/Outdoor/Landscape



Model No.	LED Brand	Color	Beam	PowerMode	Input	Wiring	Cable	Power	Luminous Flux	Dimension	DrillSize
LP100	CREE	WW3000K	S24/40/F60	Constant voltage	24VDC	Parallel	1.1M 2X0.75mm <sup>2</sup> Cable	16W	1600LM	D100X277	N/A
LP100	CREE	NW4200K	S24/40/F60	Constant voltage	24VDC	Parallel	1.1M 2X0.75mm <sup>2</sup> Cable	16W	1600LM	D100X277	N/A
LP100	CREE	CW5000K	S24/40/F60	Constant voltage	24VDC	Parallel	1.1M 2X0.75mm <sup>2</sup> Cable	16W	1760LM	D100X277	N/A

\*IES Data support.

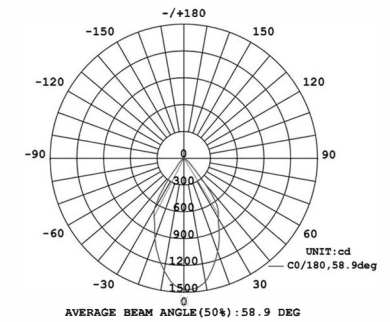
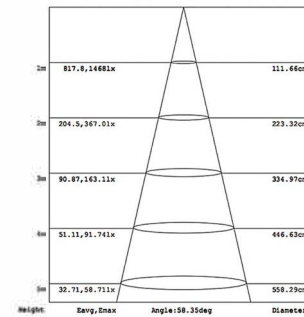

LP131 SPIKE LIGHT



DESCRIPTION

<b>LED LIGHT SOURCE</b>	High Power LED
<b>LIGHT COLOR</b>	CW, WW, NW, Red, Green, Blue, Amber
<b>MATERIAL</b>	SUS316
<b>OPTICS</b>	S12° / F45°
<b>POWER</b>	1W
<b>POWER SUPPLY</b>	N/A
<b>DIMENSION</b>	D42X420
<b>WEIGHT</b>	630g
<b>IP RATING</b>	IP65
<b>APPROVALS</b>	CE, RoHS, IP
<b>AMBIENT TEMPERATURE</b>	-20°C ~ +45°C
<b>AVERAGE LIFE</b>	50,000Hrs
<b>ACCESSORIES(OPTIONAL)</b>	N/A
<b>APPLICATIONS</b>	Indoor / Outdoor / Landscape



Model No.	LED Brand	Color	Beam	PowerMode	Input	Wiring	Cable	Power	Luminous Flux	Dimension	DrillSize
LP131	CREE	CW, WW, NW, Red, Green, Blue, Amber	S12/F45	Constant current	350mA	Series	3M 2X0.75mm <sup>2</sup> Cable	1W	100LM	D42X420	N/A
LP131D	CREE	CW, WW, NW, Red, Green, Blue, Amber	S12/F45	Constant voltage	24VDC	Parallel	3M 2X0.75mm <sup>2</sup>	1.3W	100LM	D42X420	N/A

\*IES Data support.

LED Colours



LP131

Marine grade 316 stainless steel in-ground spike fixture complete with integral CREE LED package. Tempered glass. 12/45 degree beam options. No mechanical joints to light source ensures robust protection against water ingress. Product runs cool meeting all touch temperature requirements.

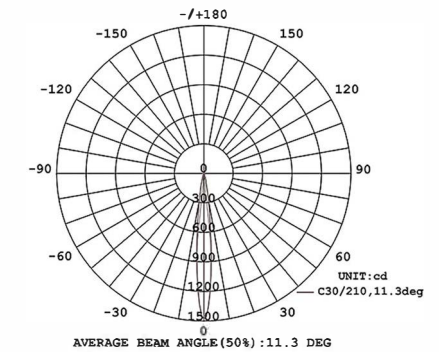
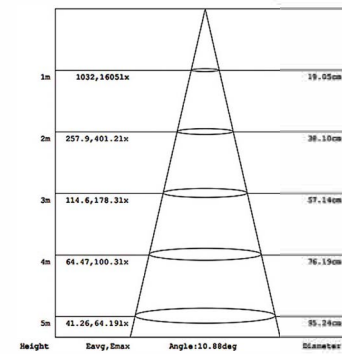
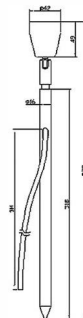

## LP133 SPIKE LIGHT



### DESCRIPTION

<b>LED Light source</b>	High Power LED
<b>Light Color</b>	CW,WW,NW,Red,Green,Blue,Amber
<b>Material</b>	SUS316
<b>Optics</b>	S20° / F60°
<b>Power</b>	3W
<b>Power supply</b>	N/A
<b>Dimension</b>	D66X465
<b>Weight</b>	925g
<b>IP Rating</b>	IP65
<b>Approvals</b>	CE,RoHS,IP
<b>Ambient temperature</b>	-20°C ~ +45°C
<b>Average life</b>	50,000Hrs
<b>Accessories(Optional)</b>	N/A
<b>Applications</b>	Indoor/Outdoor/Landscape



Model No.	LED Brand	Color	Beam	PowerMode	Input	Wiring	Cable	Power	Luminous Flux	Dimension	DrillSize
LP133	CREE	CW,WW, NW,Red Green,Blue,Amber	S20/F60	Constant current	350mA	Series	3M 2X0.75mm <sup>2</sup> Cable	3W	300LM	D66X465	N/A
LP133D	CREE	CW,WW, NW,Red Green,Blue,Amber	S20/F60	Constant voltage	12/24VDC	Parallel	3M 2X0.75mm <sup>2</sup> Cable	3.5W	300LM	D66X465	N/A

\*IES Data support.

#### LED Colours



### LP133

Marine grade 316 stainless steel in-ground spike fixture complete with integral CREE LED package. Tempered glass. 20/60 degree beam options. No mechanical joints to light source ensures robust protection against water ingress. Product runs cool meeting all touch temperature requirements.

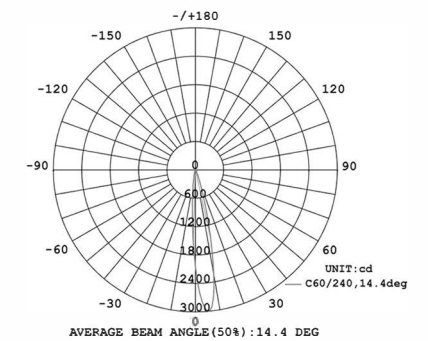
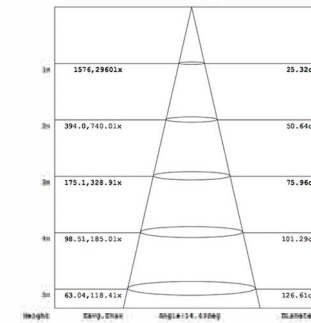



# QUICK INSTALL LIGHT





LP116D-LS GROUND LIGHT



LED Colours

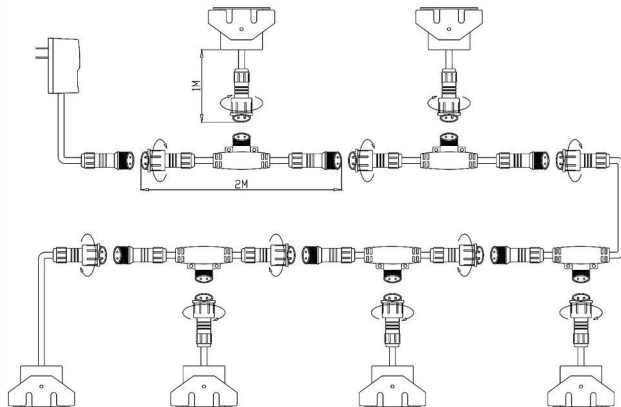

DESCRIPTION

LED LIGHT SOURCE	High Power LED
LIGHT COLOR	CW,WW,NW,Amber,Red,Green,Blue
MATERIAL	SUS316
OPTICS	See attached sheet
POWER	See attached sheet
POWER INPUT	24VDC
DIMENSION	See attached sheet
WEIGHT	N/A
IP RATING	IP65
APPROVALS	CE,RoHS
ACCESSORIES	Constant voltage Driver
APPLICATIONS	Courtyards, corridors, squares, etc

Model No.	LED Brand	Color	Beam	PowerMode	Input	Wiring	Cable	Power	Luminous Flux	Dimension	DrillSize
LP116D-LS	CREE	CW,WW, NW,Red Green,Blue,Amber	S12/F45	Constant voltage	24VDC	Parallel	2X0.75mm <sup>2</sup> Plug	6x1.3W	600LM	D60XH45	D50
LP140D-LS	CREE	CW,WW, NW,Red Green,Blue,Amber	S20/F60	Constant voltage	24VDC	Parallel	2X0.75mm <sup>2</sup> Plug	6x3.5W	1800LM	D76XH47	D65
LP166D-LS	CREE	CW,WW, NW,Red Green,Blue,Amber	S10/F40	Constant voltage	24VDC	Parallel	2X0.75mm <sup>2</sup> Plug	6x6.5W	3600LM	D96XH47	D85
LP168D-LS	CREE	CW,WW, NW,Red Green,Blue,Amber	S10/F40	Constant voltage	24VDC	Parallel	2X0.75mm <sup>2</sup> Plug	6x9W	4800LM	D96XH47	D85

\*IES Data support.



LP116DMX-LS GROUND LIGHT



LED Colours

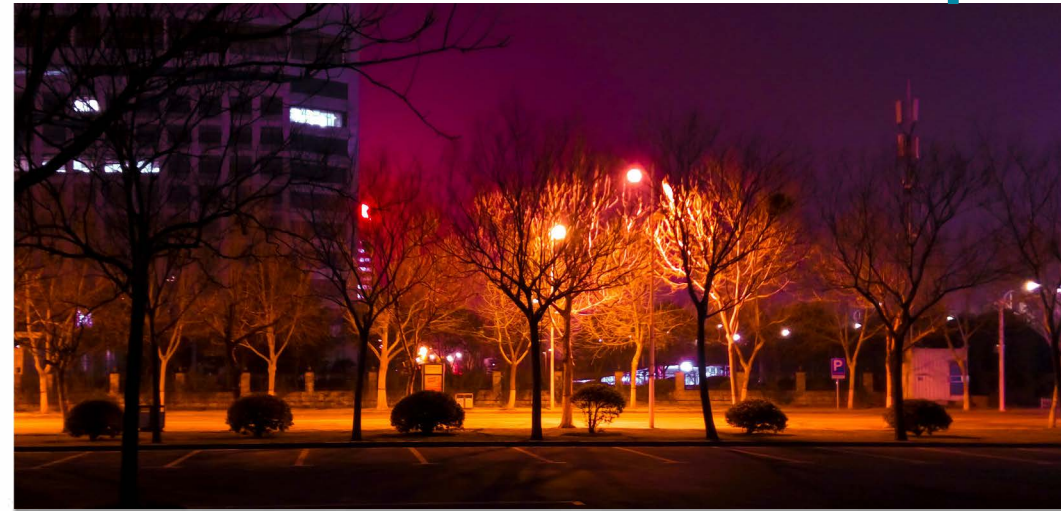
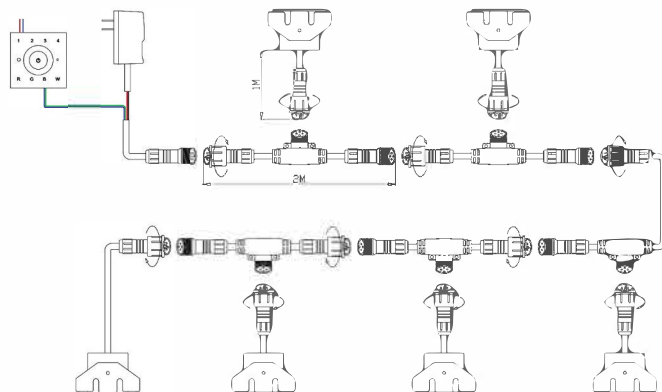
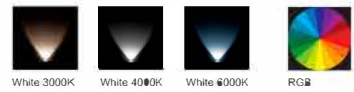

DESCRIPTION

<b>LED LIGHT SOURCE</b>	High Power LED
<b>LIGHT COLOR</b>	RGB,CW,WW,NW,Amber,Red,Green,Blue
<b>MATERIAL</b>	SUS316
<b>OPTICS</b>	See attached sheet
<b>POWER</b>	See attached sheet
<b>POWER INPUT</b>	24VDC DMX Controller
<b>DIMENSION</b>	See attached sheet
<b>WEIGHT</b>	N/A
<b>IP RATING</b>	IP65
<b>APPROVALS</b>	CE,RoHS
<b>AMBIENT TEMPERATURE</b>	-20°C ~ +45°C
<b>AVERAGE LIFE</b>	50,000Hrs
<b>ACCESSORIES</b>	Constant voltage DMX Controller
<b>APPLICATIONS</b>	Courtyards, corridors, squares, etc

Model No.	LED Brand	Color	Beam	Power Mode	Input	Wiring	Cable	Power Flux	Luminous	Direction
LP116DMX-LS	CREE	RGB,CW,WW,NW, Amber,Red,Green,Blue	S12/F45	Constant voltage	24VDC DMX Controller	Parallel	4X0.5mm <sup>2</sup> Plug	6x1.5W	N/A	D60XH45 D50
LP140DMX-LS	CREE	RGB,CW,WW,NW, Amber,Red,Green,Blue	S20/F60	Constant voltage	24VDC DMX Controller	Parallel	4X0.5mm <sup>2</sup> Plug	6x3.5W	N/A	D76XH47 D65
LP166DMX-LS	CREE	RGB,CW,WW,NW, Amber,Red,Green,Blue	S10/F40	Constant voltage	24VDC DMX Controller	Parallel	4X0.5mm <sup>2</sup> Plug	6x6.5W	N/A	D96XH47 D85
LP168DMX-LS	CREE	RGB,CW,WW,NW, Amber,Red,Green,Blue	S10/F40	Constant voltage	24VDC DMX Controller	Parallel	4X0.5mm <sup>2</sup> Plug	6x9W	N/A	D96XH47 D85

DMX decoder in built

\*IES Data support.





LP118RGB-LS GROUND LIGHT



LED Colours



RGB

Input:100-240AC  
Output:24VDC



RF remote

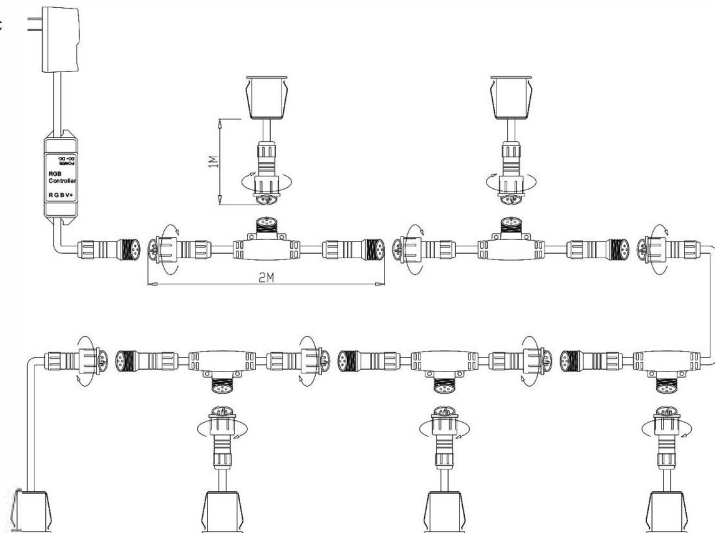

DESCRIPTION

LIGHT SOURCE	High Power LED
LIGHT COLOR	RGB
MATERIAL	SUS316
OPTICS	120°
POWER	See attached sheet
POWER INPUT	24VDC RGB Controller
DIMENSION	See attached sheet
WEIGHT	N/A
IP RATING	IP65
APPROVALS	CE,RoHS
AMBIENT TEMPERATURE	-20°C ~ +45°C
AVERAGE LIFE	50,000Hrs
ACCESSORIES	Constant voltage RGB Controller
APPLICATIONS	Courtyards, corridors, squares, etc

Model No.	LED Brand	Color	Beam	PowerMode	Input	Wiring	Cable	Power	Luminous Flux	Dimension	DrillSize
LP118RGB-LS	Edison	RGB	120	Constant voltage	24VDC RGB Controller	Parallel	4X0.5mm2 Plug	6X1W	N/A	D36.3XH37	D29
LP550RGB-LS	Edison	RGB	120	Constant voltage	24VDC RGB Controller	Parallel	4X0.5mm2 Plug	6X3W	N/A	76XH47	D65

\*IES Data support.





# ACCESSORIES

SPECIALIZED MANUFACTURER  
LED LIGHTING PRODUCTS





# PRODUCT FITTING ACCESSORIES

## INSTALLATION SLEEVE FOR LAMP DESCRIPTION

Material: Aluminium



LP130



LP140



LP116

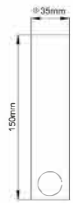

LP119



LP119T



LP118



LP118T

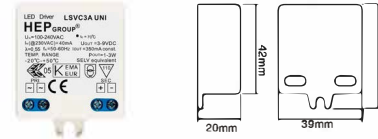

**Model: LSVCS3A**  
 LED Type: High Power LED 1W x 1 to 3  
 Supply Voltage: 100~240V AC  
 Supply Current (@230V AC) : 40mA  
 Frequency: 50/60Hz  
 Power Factor: 0.55  
 Constant Output Current: 350mA  
 Rated Output Power: 1~3W  
 Rated Output Voltage: 3~9V DC  
 Temp Range: -20°C ~ +50°C  
 Tc = 70°C  
 Size: 39 x 42 x 20mm  
 Weight: 30g  
 Approbations:



**Model: LSC6W350**  
 LED Type: High Power LED 1W x 3 to 6  
 Supply Voltage: 100 ~ 240V AC  
 Supply Current: 36mA.  
 Frequency: 50/60Hz  
 Power Factor: 0.9  
 Constant Output Current: 350mA  
 Rated Output Power: 3~6W  
 Rated Output Voltage: 8.6~18V DC  
 Temp Range: -20°C ~ +50°C  
 Tc = 80°C  
 Size: 55.5 x 38.5 x 22mm  
 Weight: g  
 Approbations:

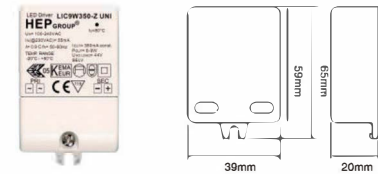

**Model: LIC9W350-Z**  
 LED Type: High Power LED 1W x 6 to 9  
 Supply Voltage: 100 ~ 240V AC  
 Supply Current: 130mA Max.  
 Frequency: 50/60Hz  
 Power Factor: 0.9  
 Constant Output Current: 350mA  
 Rated Output Power: 6~ 9W  
 Rated Output Voltage: 17.1~25.7V DC  
 Temp Range: -20°C ~ +50°C  
 Tc = 80°C  
 Size: 65 x 39 x 20mm  
 Weight: 48g  
 Approbations:

# PRODUCT FITTING ACCESSORIES



**Model: LMC15W350-Z**  
 LED Type: High Power LED 1W x 10 to 15  
 Supply Voltage: 220~240V AC  
 Supply Current: 95mA Max.  
 Frequency: 50/60Hz  
 Power Factor: 0.9  
 Constant Output Current: 350mA  
 Rated Output Power: 9.1~15W  
 Rated Output Voltage: 26~43V DC  
 Temp Range: -20°C ~ +50°C  
 Tc = 80°C  
 Size: 85 x 41 x 22mm  
 Weight: 55 g  
 Approbations:



**Model: LBC20W350-Z**  
 LED Type: High Power LED 1W x 13 to 20  
 Supply Voltage: 100-240V AC  
 Supply Current: 245mA Max.  
 Frequency: 50/60Hz  
 Power Factor: 0.9  
 Constant Output Current: 350mA  
 Rated Output Power: 13~20W  
 Rated Output Voltage: 35~ 58V DC  
 Temp Range: -20°C ~ +50°C  
 Tc = 85°C  
 Size: 117 x 44 x 30mm  
 Weight: 86g  
 Approbations:

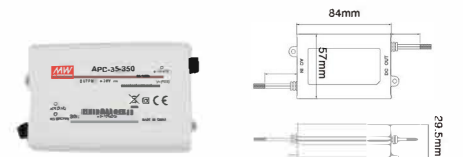

**Model: APC-35-350**  
 LED Type: High Power LED 1W x 10 to 35  
 Supply Voltage: 100-240V AC  
 Supply Current: 500mA Max.  
 Frequency: 50/60Hz  
 Power Factor: 0.84  
 Constant Output Current: 350mA  
 Rated Output Power: 10~ 35W  
 Rated Output Voltage: 28~ 100V DC  
 Temp Range: -30°C ~ +70°C  
 Tc = 80°C  
 Size: 84 x 57 x 29.5mm  
 Weight: 150g  
 Approbations:



PRODUCT FITTING ACCESSORIES

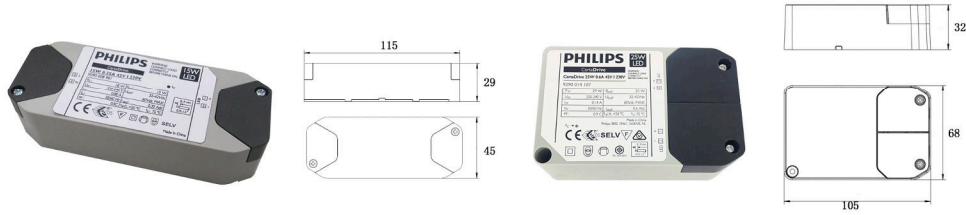

Model: CertaDrive 15W 0.35A 42V  
 LED Type: High Power LED 15W  
 Supply Voltage: 220~240V AC  
 Supply Current: 0.08A  
 Frequency: 50/60Hz  
 Power Factor:  $\geq 0.9$   
 Constant Output Current: 350mA  
 Rated Output Power: 11~15W  
 Rated Output Voltage: 32~42V DC  
 Temp Range: 0°C ~ +50°C  
 Tc = 75°C  
 Size: 115 x 45 x 29mm  
 Approbations:

Model: CertaDrive 25W 0.6A 42V  
 LED Type: High Power LED 25W  
 Supply Voltage: 220~240V AC  
 Supply Current: 0.14A  
 Frequency: 50/60Hz  
 Power Factor:  $\geq 0.9$   
 Constant Output Current: 600mA  
 Rated Output Power: 20~25W  
 Rated Output Voltage: 32~42V DC  
 Temp Range: 0°C ~ +50°C  
 Tc = 75°C  
 Size: 105 x 68 x 32mm  
 Approbations:

PRODUCT FITTING ACCESSORIES

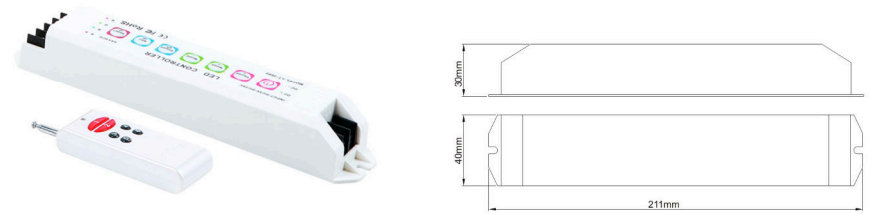

Model:LT-3600

LT-3600RF multi function LED controller is a universal RGB controller with high-performance, adopted the most advanced PWM control technology. It's dedicated to control entire RGB color changes of LED lights with 4 wires (common anode), such as RGB LED module, LED strip, and other LED lights.



Model NO.	Output Voltage	Output Current	Output Watts
DE-60-06W	6VAC	10A	60W
DE-60-7.5W	7.5VAC	8A	60W
DE-60-09W	9VAC	6.67A	60W
DE-60-12W	12VAC	5A	60W
DE-60-15W	15VAC	4A	60W
DE-60-18W	18VAC	3.33A	60W
DE-60-20W	20VAC	3A	60W
DE-60-22W	22VAC	2.73A	60W
DE-60-24W	24VAC	2.5A	60W
DE-20-12W	12VAC	1.67A	20W



Input:230/240VAC 50Hz  
 Standard:EN61558-1 EN61558-2-6  
 Approval:EUROPE,UK,SAA  
 Size:102x64x74mm  
 Weight:1450g

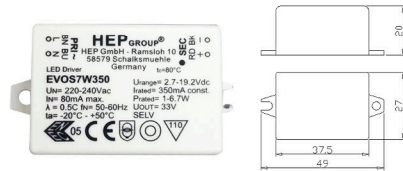

Model: EVOS7W350  
 LED Type: High Power LED 1W x 1 to 6  
 Supply Voltage: 200~240V AC  
 Supply Current: 80mA.  
 Frequency: 50/60Hz  
 Power Factor: 0.5  
 Constant Output Current: 350mA  
 Rated Output Power: 1~6.7W  
 Rated Output Voltage: 2.7~19.2V DC  
 Temp Range: -20°C ~ +50°C  
 Tc = 80°C  
 Size: 49 x 27 x 20mm

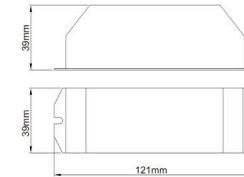

Model:3090-350

LED Constant Current Power Repeater  
 Input Voltage: DC12V-DC48V  
 Output Current: 350mA/CH  
 Output Power: 16.8W \*3CH  
 Driving quantity: 1~12pcs hi-power 1W LED×3CH  
 Drive 1-3W/CH @ INPUT DC12V  
 Drive 1-6W/CH @INPUT DC24V  
 Drive 1-10W/CH @INPUT DC36V  
 Drive 1-12W/CH @INPUT DC48V

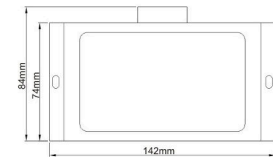

Model:3800-350

Constant Current RGB LED Controller  
 Input Voltage: DC12V-DC48V  
 Output Current: 350mA/CH  
 Output Power: 16.8W \*3CH  
 Driving quantity: 1~12pcs hi-power 1W LED×3CH  
 Drive 1-3W/CH @ INPUT DC12V  
 Drive 1-6W/CH @ INPUT DC24V  
 Drive 1-10W/CH @INPUT DC36V  
 Drive 1-12W/CH @INPUT DC48V

PRODUCT FITTING ACCESSORIES



**DX8**  
 RGB Touch Panel  
 Input Voltage: 100-240VAC  
 Output Signal: RF2.4G+DMX512  
 RF Remote Distance: 30M  
 Control Mode: 4 Zones Control

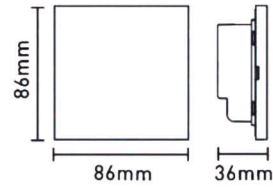
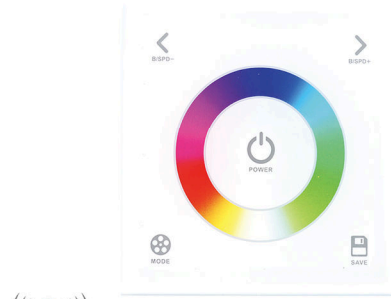

Touch Panel

**DX3**  
 RGB Touch Panel  
 Input Voltage: 100-240VAC  
 Output Signal: RF2.4G+DMX512  
 RF Remote Distance: 30M

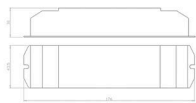

**R4-CC**  
 2.4G Wireless Remote Control(Constant Current)  
 Input Voltage: DC12V DC48V  
 Output Voltage: DC3V 46V  
 Output current: CC 350/700/1050mA×4CH(3in1)  
 Output Power: 1.05W-48.3W×4CH Max 193.2W  
 Ambient temperature: -30°C +55°C  
 Dimension L175×W44×H30mm  
 Weight165g

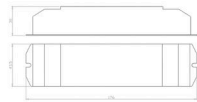

**R4-5A**  
 2.4G Wireless Remote Control(Constant Voltage)  
 Input Voltage: DC5V-DC24V  
 Max current: 5Ax4CH Max 20A  
 Max Power: 100W/240W/480W(5V/12V/24V)  
 Ambient temperature: -30°C +55°C  
 Dimension L175×W44×H30mm  
 Weight150g

PRODUCT FITTING ACCESSORIES



Mini M3+M3-3A

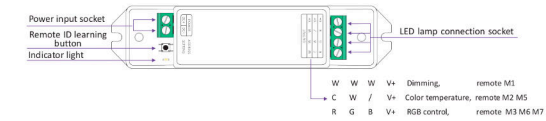
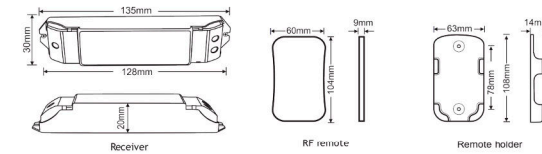

1.Parameter:

**Receiver:**  
 Model:M3-3A  
 Power Input:12-24V DC  
 Max Current Load: Max 3Ax3CH  
 Max Output Power: 108W(12V)216W(24V)  
 Working Temp: -30°C-55°C  
 Dimensions:L135xW30xH20(mm)  
 Weight(N.W.)47g  
 Total Weight(G.W.)135g

**Receiver:**  
 Model:M3/M6/M7  
 Working Voltage:3V(battery CR2032)  
 Working Frequency:433.92MHz  
 Remote Distance:30m  
 Working Temp: -30°C-55°C  
 Dimensions:L104xW58xH9(mm)  
 Weight(N.W.)42g

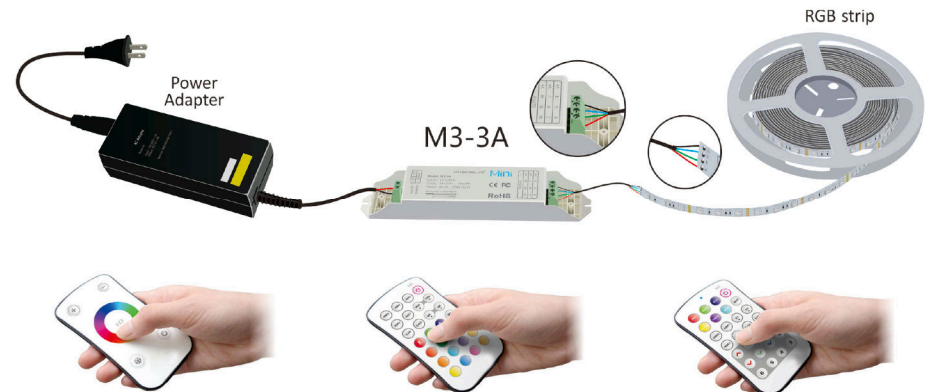

**PRODUCT FITTING ACCESSORIES**

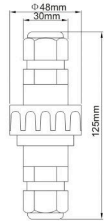
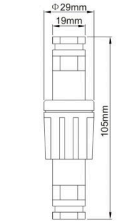

Model: WJM2/4P  
 Applied Type:  
 Voltage:0-250V AC MAX  
 Electric Current: 6A MAX  
 Colour: Black  
 IP Rating: IP68  
 Applicable Diameter of Cable:5-8mm

Weight:38g  
 Approbations: CE

Model: WJ-4P  
 Applied Type:  
 Voltage:0-250V AC MAX  
 Electric Current: 10A MAX  
 Colour: Black  
 IP Rating: IP68  
 Applicable Diameter of Cable:6-10mm

Weight:94g  
 Approbations: CE

Name: Parallel T type three way  
 waterproof plug connector 2P / 4P

Model: 3T  
 Input: max 300V  
 rated current: 13A  
 IP Rating: IP67  
 Applicable Diameter of Cable: 5---9mm  
 Insulator material: Nylon  
 Connection mode: screw type

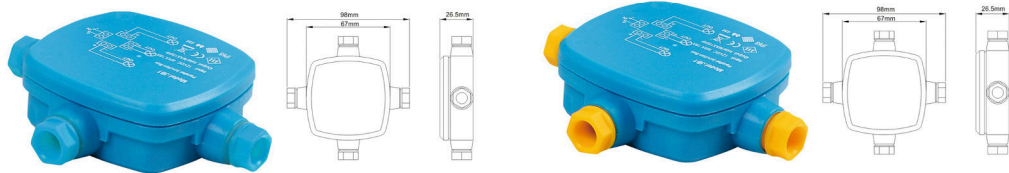

Name:Series Junction Box  
 Model:AJBLED/P  
 Input:MAX.5A  
 Output:total MAX 150W  
 Colour:Blue  
 IP Rating:IP68  
 Waterproof depth:4M  
 Approbations: CE

Name:Parallel Junction Box  
 Model:AJBLED/P  
 Input:12V DC MAX.16A  
 Output:total MAX 150W  
 Colour:Blue  
 IP Rating:IP68  
 Waterproof depth:4M  
 Approbations: CE

**PRODUCT FITTING ACCESSORIES**

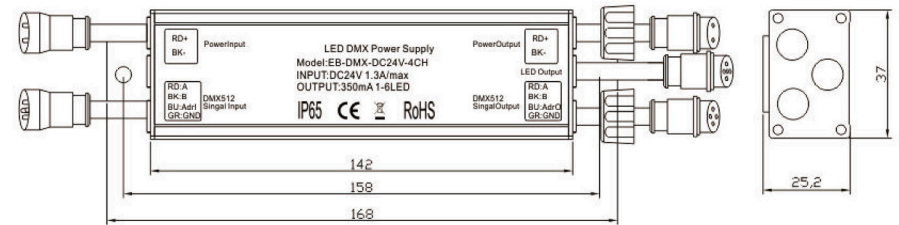

EB-DMX-DC24V-6X1W-4CH  
 LED DMX Power Supply  
 Input Voltage:DC24V  
 Output Current:350mA/CH\*4CH  
 Output Power:1-6W\*4CH  
 Driving quantity:1-6pcs hi-power LED x 4CH  
 350mA:1-6pcs hi-power 1W LED

EB-DMX-12X1W-4CH  
 LED DMX Power Supply  
 Input Voltage:DC48V  
 Output Current:350mA/CH\*4CH  
 Output Power:10-12W\*4CH  
 Driving quantity:10-12pcs hi-power LED x 4CH  
 350mA:1-6pcs hi-power 1W LED



PRODUCT FITTING ACCESSORIES



M20B waterproof Male&Female plug



M20B waterproof Male&Female plug extended line

Model:M20B-2P Tee waterproof connector  
M20B-2P waterproof Male&Female plug  
Approval:CE  
Current:15A MAX  
Colour:Black  
IP Rating:IP67

Model:M20B-4P Tee waterproof connector  
M20B-4P waterproof Male&Female plug  
Approval:CE  
Current:12A MAX  
Colour:Black  
IP Rating:IP67



FQ16-2P waterproof extended line

Model:FQ16-2P Waterproof adapter  
Approval:CE  
Current:10A MAX  
Colour:Black  
IP Rating:IP67

PRODUCT FITTING ACCESSORIES



Model:S03-3P Assembly type waterproof connector  
Applied Type:  
Voltage:500V AC MAX  
Electric Current: 15A MAX  
Colour:Black  
IP Rating: IP67  
Applicable Diameter of Cable: 6-9mm



Model:RC-077 Assembly type waterproof connector  
Applied Type:  
Voltage:250V AC MAX  
Electric Current: 16A MAX  
Colour:Black  
IP Rating: IP68  
Applicable Diameter of Cable: 6.5-9mm



Model:S03-5P Assembly type waterproof connector  
Applied Type:  
Voltage:500V AC MAX  
Electric Current: 5A MAX  
Colour:Black  
IP Rating: IP67  
Applicable Diameter of Cable: 6-9mm



UY2 quick waterproof connector  
Use cable 0.2-0.5mm<sup>2</sup>  
not suitable for high voltage



Name:Waterproof connection plug  
Model: S06  
Input:max 500V  
rated current: 8A  
IP Rating: IP68  
Applicable Diameter of Cable:5---9mm

**FOUNTAIN LIGHT**



LP09/10 LP411

**SPOT LIGHT**



LP13/14 LPL624



LP15/16-LP824



LP17/18-LP618



LP19/20-LP612



LP21/22-LP608



LP23/24 LP023



LP25/26 LP023-2L



LP27/28 LP021



LP29/30 LP026

**GROUND LIGHT**



LP33/34 LP100



LP35/36 LP310



LP37/38 LP240



LP39/40 LP240



LP41/42 LP120



LP43/44 LP080



LP45/46 LP112



LP47/48 LP112H



LP49/50 LP116



LP51/52 LP116H



LP53/54 LP116Q



LP55/56 LP116SQ



LP57/58 LP48SQ



LP59/60 LP118



LP61/62 LP118T



LP63/64 LP119



LP65/66 LP119T



LP67/68 LP119CT



LP69/70 LP119SQ



LP71/72 LP129



LP73/74 LP108

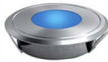

LP75/76 LP308



LP77/78 LP117



LP79/80 LP130



LP81/82 LP140



LP83/84 LP140SQ



LP85/86 LP150



LP87/88 LP550RGB



LP89/90 LP151



LP91/92 LP166



LP93/94 LP168



LP95/96 LP191



LP97/98 LP266



LP99/100 LP268

**LINE LIGHT**



LP103/104 LP2001



LP105/106 LP26



LP107/108 LP26HP



LP109/110 LP27



LP111/112 LP700D



LP113/114 LP710

**LED COMPONENTS**



LP117/118 LED03



LP119/120 LED09

**WALL LIGHT**



LP123/124 LP1808



LP125/126 LP1820



LP127/128 LP101



LP29/130 LP102



LP131/132 LP102-L



LP133/134 MLP103



LP135/136 LPL104



LP137/138 MLP105

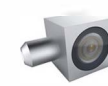

LP139/140 LP110



LP141/142 LP110-L



LP143/144 LP305

## SPIKE LIGHT



LP47/148 LP100



LP149/150 LP131



LP151/152 LP133

## QUICK INSTALL LIGHT



LP155/156 LP116D-LS



LP157/158 LP116DMX-LS



LP159/160 LP118RGB-LS

## ACCESSORIES



LP163 TS130



LP163 TS140



LP163 TS116



LP163 TS119



LP163 TS119T



LP163 TS118



LP163 TS118T



P186 LSV3A



P164 LMC15W350-Z



P164 LSC6W350



P164 LBC20W350-Z



P164 LIC9W350-Z



P164 APC-35-350



P165  
CertaDrive 15W 0.35A 42V



P165  
CertaDrive 25W 0.6A 42V



P165 DE-60



P165 EVOS7W350



P166 LT-3600



P166 3090-350



P166 3800-350



P167 DX8



P167 DX3



P167 R4-CC



P167 R4-5A



P168  
Mini M3+M3-3A



P167 WJM2/4P



P169 3T



P169 3T



P169 AJBLED/P



P169 AJBLED/P



P170  
EB-DMX-12X1W-4CH



P170  
EB-DMX-DC24V-6X1W-4CH



P171 M20B



P171 FQ16-2P



P172 S03-3P



P172 RC-077



P172 S03-5P



P172 UY2



P172 S06

# Samui phangan real estate

BUYING • RENOVATING INVESTING • LIVING

## CALLISTO VILLAS

Unsurpassed Eco Friendly Luxury

Outdoor Living Trends For 2015

Seara Sports  
Your Only Fitness Solution

